



GIVING THE PAST A FUTURE

*Secol*

Archival Storage &  
Presentation Systems



By Appointment  
to Her Majesty the Queen  
Manufacturers of Archival and  
Photographic Storage Systems  
Secol Limited Thetford



## POSITIVE AND DEFINITIVE ARCHIVAL PROTECTION

Just about all of us possess unique archival material, kept for hobby, professional, financial, or sentimental reasons. Whatever the value of documents, photographs, maps, pictures, postcards, labels, stamps, coins and other various precious memorabilia is, you may find it important and worth taking time and effort to ensure they stay in the best possible condition for the future.

Whether you are a private or professional collector, family historian, librarian, archivist, photographer or conservator, you will find many useful items on our website to protect your media.

SECOL is proud to supply the best quality Archival Polyester Enclosures in the world and our Polyester acid-free film perfectly fills, the often conflicting needs of conservation, protection and accessibility.

It is a chemically inert, extremely clear and immensely strong material which uniquely combines security, long-life functional use and versatility for all kinds of material formats.

We do our best to hold the widest range of products in stock to provide you with prompt delivery.

We are also able to discuss your own ideas whether they are about a special size, colour, or shape, while still maintaining the highest quality of both our manufacture and service.

Please do not hesitate to mail or telephone us with your bespoke requirements.

---

Our competent and friendly staff are available to offer outstanding customer support, advice and additional information

Monday - Thursday 9am - 4:45pm  
Friday 9am - 2pm

Tel: 01842 752 341  
Email: [sales@secol.co.uk](mailto:sales@secol.co.uk)  
Website: [www.secol.co.uk](http://www.secol.co.uk)

## Where to Find...

<table border="0"> <tr> <td><b>I. Binders and Portfolios</b></td> <td style="text-align: right;"><b>4</b></td> </tr> <tr> <td>1. Binders</td> <td style="text-align: right;">4</td> </tr> <tr> <td>2. Portfolios</td> <td style="text-align: right;">6</td> </tr> <tr> <td>3. Portfolio Boxes with Pockets &amp; Covers</td> <td style="text-align: right;">6</td> </tr> </table>	<b>I. Binders and Portfolios</b>	<b>4</b>	1. Binders	4	2. Portfolios	6	3. Portfolio Boxes with Pockets & Covers	6	<table border="0"> <tr> <td><b>VIII. CD, DVD &amp; Vinyl Storage</b></td> <td style="text-align: right;"><b>33</b></td> </tr> <tr> <td>1. A4 Format CD &amp; DVD System Storage</td> <td style="text-align: right;">33</td> </tr> <tr> <td>2. CD Format Storage</td> <td style="text-align: right;">33</td> </tr> <tr> <td>3. Vinyl Protection &amp; Storage</td> <td style="text-align: right;">34</td> </tr> </table>	<b>VIII. CD, DVD &amp; Vinyl Storage</b>	<b>33</b>	1. A4 Format CD & DVD System Storage	33	2. CD Format Storage	33	3. Vinyl Protection & Storage	34														
<b>I. Binders and Portfolios</b>	<b>4</b>																														
1. Binders	4																														
2. Portfolios	6																														
3. Portfolio Boxes with Pockets & Covers	6																														
<b>VIII. CD, DVD &amp; Vinyl Storage</b>	<b>33</b>																														
1. A4 Format CD & DVD System Storage	33																														
2. CD Format Storage	33																														
3. Vinyl Protection & Storage	34																														
<table border="0"> <tr> <td><b>II. Filing Pages for Binders &amp; Portfolios</b></td> <td style="text-align: right;"><b>7</b></td> </tr> <tr> <td>1. Standard A-S Vertical A4 Format Pages</td> <td style="text-align: right;">7</td> </tr> <tr> <td>2. Binder Style Display Pages</td> <td style="text-align: right;">8</td> </tr> <tr> <td>3. Security Style Display Pages</td> <td style="text-align: right;">8</td> </tr> <tr> <td>4. Certificate Pages</td> <td style="text-align: right;">9</td> </tr> <tr> <td>5. Panoramic Pages</td> <td style="text-align: right;">9</td> </tr> <tr> <td>6. Hanging A-S A4 Format Pages</td> <td style="text-align: right;">10</td> </tr> </table>	<b>II. Filing Pages for Binders &amp; Portfolios</b>	<b>7</b>	1. Standard A-S Vertical A4 Format Pages	7	2. Binder Style Display Pages	8	3. Security Style Display Pages	8	4. Certificate Pages	9	5. Panoramic Pages	9	6. Hanging A-S A4 Format Pages	10	<table border="0"> <tr> <td><b>VIII. Acid-Free Boxes, Holders &amp; Protectors</b></td> <td style="text-align: right;"><b>35</b></td> </tr> <tr> <td>1. Standard Archival Boxes</td> <td style="text-align: right;">35</td> </tr> <tr> <td>2. Die-Cut Corrugated Boxes</td> <td style="text-align: right;">37</td> </tr> <tr> <td>3. Memory Boxes</td> <td style="text-align: right;">38</td> </tr> <tr> <td>4. Presentation Boxes</td> <td style="text-align: right;">38</td> </tr> <tr> <td>5. Archive Holders &amp; Corner Protectors</td> <td style="text-align: right;">38</td> </tr> </table>	<b>VIII. Acid-Free Boxes, Holders &amp; Protectors</b>	<b>35</b>	1. Standard Archival Boxes	35	2. Die-Cut Corrugated Boxes	37	3. Memory Boxes	38	4. Presentation Boxes	38	5. Archive Holders & Corner Protectors	38				
<b>II. Filing Pages for Binders &amp; Portfolios</b>	<b>7</b>																														
1. Standard A-S Vertical A4 Format Pages	7																														
2. Binder Style Display Pages	8																														
3. Security Style Display Pages	8																														
4. Certificate Pages	9																														
5. Panoramic Pages	9																														
6. Hanging A-S A4 Format Pages	10																														
<b>VIII. Acid-Free Boxes, Holders &amp; Protectors</b>	<b>35</b>																														
1. Standard Archival Boxes	35																														
2. Die-Cut Corrugated Boxes	37																														
3. Memory Boxes	38																														
4. Presentation Boxes	38																														
5. Archive Holders & Corner Protectors	38																														
<table border="0"> <tr> <td><b>III. Hanging File Storage System</b></td> <td style="text-align: right;"><b>12</b></td> </tr> <tr> <td>1. Wide Format Hanging Files</td> <td style="text-align: right;">12</td> </tr> </table>	<b>III. Hanging File Storage System</b>	<b>12</b>	1. Wide Format Hanging Files	12	<table border="0"> <tr> <td><b>IX. Large Polyester Enclosure Formats &amp; Storage</b></td> <td style="text-align: right;"><b>39</b></td> </tr> <tr> <td>1. Large Polyester Enclosures</td> <td style="text-align: right;">39</td> </tr> <tr> <td>2. Horizontal Plan Chests</td> <td style="text-align: right;">39</td> </tr> </table>	<b>IX. Large Polyester Enclosure Formats &amp; Storage</b>	<b>39</b>	1. Large Polyester Enclosures	39	2. Horizontal Plan Chests	39																				
<b>III. Hanging File Storage System</b>	<b>12</b>																														
1. Wide Format Hanging Files	12																														
<b>IX. Large Polyester Enclosure Formats &amp; Storage</b>	<b>39</b>																														
1. Large Polyester Enclosures	39																														
2. Horizontal Plan Chests	39																														
<table border="0"> <tr> <td><b>IV. Polyester Pockets, Covers &amp; Folders</b></td> <td style="text-align: right;"><b>13</b></td> </tr> <tr> <td>1. Comprehensive "HC" Archival Pockets</td> <td style="text-align: right;">13</td> </tr> <tr> <td>2. Standard Polyester Pockets</td> <td style="text-align: right;">14</td> </tr> <tr> <td>3. Standard Polyester Covers</td> <td style="text-align: right;">17</td> </tr> <tr> <td>4. Standard Polyester Folders</td> <td style="text-align: right;">19</td> </tr> </table>	<b>IV. Polyester Pockets, Covers &amp; Folders</b>	<b>13</b>	1. Comprehensive "HC" Archival Pockets	13	2. Standard Polyester Pockets	14	3. Standard Polyester Covers	17	4. Standard Polyester Folders	19	<table border="0"> <tr> <td><b>X. Mounting Solutions</b></td> <td style="text-align: right;"><b>40</b></td> </tr> <tr> <td>1. Mounting Inserts, Board, Tissue &amp; Border Mounts</td> <td style="text-align: right;">40</td> </tr> <tr> <td>2. Mounting Strips and Tapes</td> <td style="text-align: right;">40</td> </tr> </table>	<b>X. Mounting Solutions</b>	<b>40</b>	1. Mounting Inserts, Board, Tissue & Border Mounts	40	2. Mounting Strips and Tapes	40														
<b>IV. Polyester Pockets, Covers &amp; Folders</b>	<b>13</b>																														
1. Comprehensive "HC" Archival Pockets	13																														
2. Standard Polyester Pockets	14																														
3. Standard Polyester Covers	17																														
4. Standard Polyester Folders	19																														
<b>X. Mounting Solutions</b>	<b>40</b>																														
1. Mounting Inserts, Board, Tissue & Border Mounts	40																														
2. Mounting Strips and Tapes	40																														
<table border="0"> <tr> <td><b>V. Polyester Sleeves &amp; Sleeve Rolls</b></td> <td style="text-align: right;"><b>23</b></td> </tr> <tr> <td>1. Standard Polyester Sleeves</td> <td style="text-align: right;">23</td> </tr> <tr> <td>2. Postcard Sleeves</td> <td style="text-align: right;">26</td> </tr> <tr> <td>3. Transleeves</td> <td style="text-align: right;">26</td> </tr> <tr> <td>4. Colourview Sleeves &amp; Black Masks</td> <td style="text-align: right;">27</td> </tr> <tr> <td>5. Trantec Sleeves</td> <td style="text-align: right;">28</td> </tr> <tr> <td>6. Stereo Sleeves</td> <td style="text-align: right;">28</td> </tr> <tr> <td>7. Divided Index Sleeves</td> <td style="text-align: right;">28</td> </tr> <tr> <td>8. Transleeve, Colourview &amp; Trantec Tolls</td> <td style="text-align: right;">29</td> </tr> </table>	<b>V. Polyester Sleeves &amp; Sleeve Rolls</b>	<b>23</b>	1. Standard Polyester Sleeves	23	2. Postcard Sleeves	26	3. Transleeves	26	4. Colourview Sleeves & Black Masks	27	5. Trantec Sleeves	28	6. Stereo Sleeves	28	7. Divided Index Sleeves	28	8. Transleeve, Colourview & Trantec Tolls	29	<table border="0"> <tr> <td><b>XI. Archival Accessories</b></td> <td style="text-align: right;"><b>42</b></td> </tr> <tr> <td>1. Interleaves &amp; Tissue</td> <td style="text-align: right;">42</td> </tr> <tr> <td>2. Labels, Index Cards &amp; Marker Pens</td> <td style="text-align: right;">42</td> </tr> <tr> <td>3. Polyester Rolls</td> <td style="text-align: right;">43</td> </tr> <tr> <td>4. Handling Accessories</td> <td style="text-align: right;">43</td> </tr> <tr> <td>5. Conservation Pack</td> <td style="text-align: right;">43</td> </tr> </table>	<b>XI. Archival Accessories</b>	<b>42</b>	1. Interleaves & Tissue	42	2. Labels, Index Cards & Marker Pens	42	3. Polyester Rolls	43	4. Handling Accessories	43	5. Conservation Pack	43
<b>V. Polyester Sleeves &amp; Sleeve Rolls</b>	<b>23</b>																														
1. Standard Polyester Sleeves	23																														
2. Postcard Sleeves	26																														
3. Transleeves	26																														
4. Colourview Sleeves & Black Masks	27																														
5. Trantec Sleeves	28																														
6. Stereo Sleeves	28																														
7. Divided Index Sleeves	28																														
8. Transleeve, Colourview & Trantec Tolls	29																														
<b>XI. Archival Accessories</b>	<b>42</b>																														
1. Interleaves & Tissue	42																														
2. Labels, Index Cards & Marker Pens	42																														
3. Polyester Rolls	43																														
4. Handling Accessories	43																														
5. Conservation Pack	43																														
<table border="0"> <tr> <td><b>VI. Slides, Film &amp; Negatives Preserving and Storage</b></td> <td style="text-align: right;"><b>30</b></td> </tr> <tr> <td>1. Vertical &amp; Hanging A-S A4 Format Pages</td> <td style="text-align: right;">30</td> </tr> <tr> <td>2. Contact Print Sheets</td> <td style="text-align: right;">31</td> </tr> <tr> <td>3. Transleeve &amp; Colourview Divided Sheets</td> <td style="text-align: right;">31</td> </tr> <tr> <td>4. Tecs Sleeves</td> <td style="text-align: right;">31</td> </tr> <tr> <td>5. Slide Security Pockets with Labels</td> <td style="text-align: right;">32</td> </tr> <tr> <td>6. Four Flap Folders &amp; Plain Sheets</td> <td style="text-align: right;">32</td> </tr> </table>	<b>VI. Slides, Film &amp; Negatives Preserving and Storage</b>	<b>30</b>	1. Vertical & Hanging A-S A4 Format Pages	30	2. Contact Print Sheets	31	3. Transleeve & Colourview Divided Sheets	31	4. Tecs Sleeves	31	5. Slide Security Pockets with Labels	32	6. Four Flap Folders & Plain Sheets	32	<table border="0"> <tr> <td><b>XII. Bespoke Service</b></td> <td style="text-align: right;"><b>44</b></td> </tr> <tr> <td><b>XIII. Glossary of Terms</b></td> <td style="text-align: right;"><b>46</b></td> </tr> <tr> <td><b>XIV. Polyester Properties &amp; Archive Storage Guidelines</b></td> <td style="text-align: right;"><b>46</b></td> </tr> </table>	<b>XII. Bespoke Service</b>	<b>44</b>	<b>XIII. Glossary of Terms</b>	<b>46</b>	<b>XIV. Polyester Properties &amp; Archive Storage Guidelines</b>	<b>46</b>										
<b>VI. Slides, Film &amp; Negatives Preserving and Storage</b>	<b>30</b>																														
1. Vertical & Hanging A-S A4 Format Pages	30																														
2. Contact Print Sheets	31																														
3. Transleeve & Colourview Divided Sheets	31																														
4. Tecs Sleeves	31																														
5. Slide Security Pockets with Labels	32																														
6. Four Flap Folders & Plain Sheets	32																														
<b>XII. Bespoke Service</b>	<b>44</b>																														
<b>XIII. Glossary of Terms</b>	<b>46</b>																														
<b>XIV. Polyester Properties &amp; Archive Storage Guidelines</b>	<b>46</b>																														
<table border="0"> <tr> <td><b>VII. Archival Board Folders</b></td> <td style="text-align: right;"><b>32</b></td> </tr> </table>	<b>VII. Archival Board Folders</b>	<b>32</b>	<table border="0"> <tr> <td><b>XV. Request Form</b></td> <td style="text-align: right;"><b>47</b></td> </tr> </table>	<b>XV. Request Form</b>	<b>47</b>																										
<b>VII. Archival Board Folders</b>	<b>32</b>																														
<b>XV. Request Form</b>	<b>47</b>																														

# I Binders and Portfolios

The Secol Binders & Portfolios give the ultimate solution for bringing order, accessibility and professional presentation to mixed materials and formats.

The Standard A-S, Boxboard, Collection, Panoramic & Certificate Binders use the principle of a "binder-within-a-box" to provide primary protection and useful logical order with archival storage. Binders with separate Slipcases provide all-round protection and are an alternative to the fully enclosed Standard Binders.

The Professional Archival Portfolios are available in different formats, styles and volumes to meet varying requirements. They offer a totally safe and flexible presentation systems for browsing, storage and display of digital or conventional prints from A4 to A2.

Portfolios are portable, smart and offer exceptional image presentation. Mini Portfolio is complete with pages for 20 images.

Zip Case Portfolios are supplied with or without pockets.

Portfolio Boxes come with 25 pockets or covers but will accommodate a further 50 items.

Pockets and Covers are manufactured in 75 Micron Polyester and they fit exactly inside the frame of the box.

*For Filing Pages for Binders & Portfolios turn to page 7.*

*For Mounting Solutions turn to page 40.*

*For Labels, Marker Pens and Gloves go to Accessories on page 42.*

*Binders are available in many other sizes as Bespoke Service.*

*For a Request Form turn to page 47.*

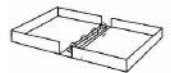
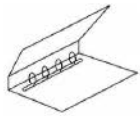

## 1 Binders

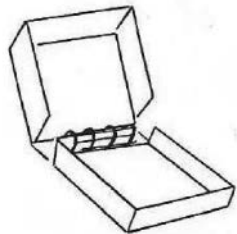

### BOXBOARD BINDERS

The Boxboard A4 and A3 Format Binders are made from the highest grade Museum Boxboard.

The Die Cut Binder in 1250 Micron folding boxboard is available in a Blue-Grey or Taupe colour.

Binders are a solid and long-lasting solution for storage, their "clamshell" closures provide a double seal against the light, dust and dirt when not in use. They have a 4 ring binder mechanism which opens up flat and permits 100% access to the material.

Binders can be stored either flat or upright and are perfect to use with: Filing Pages and the Acid-Free Mounting Systems. Capacity is 100 filing pages.

NAME	FORMAT	RINGS	COLOUR	PACK OF	REF. NO	SUITABLE FOR
Boxboard Binder	A4	4	Blue-Grey	1	GBA4	Vertical and Hanging A-S Pages, Binder and Security Style A4 Format Pages
Boxboard Binder	A4	4	Taupe	1	GBA4T	Vertical and Hanging A-S Pages, Binder and Security Style A4 Format Pages
Boxboard Binder	A3	4	Blue-Grey	1	GBA3	Binder & Security Style Display A3 Format Pages
Boxboard Binder	A3	4	Taupe	1	GBA3T	Binder & Security Style Display A3 Format Pages
B. S. Boxboard Binder	Bespoke		Blue-Grey	1	BSGB	Bespoke Service
B. S. Boxboard Binder	Bespoke		Taupe	1	BSGBT	Bespoke Service

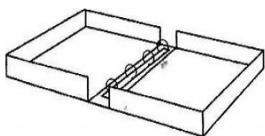

### STANDARD A-S BINDERS

The Standard A-S Binders have a solid frame and their principle of a "binder-within-a-box" perfectly keep dirt, dust and light out.

They are lined and covered with 2 standard coverings, Royal Blue Library Buckram (cloth based) and Royal Blue Bookbinder's Milskin.

The Standard A-S Binders open up flat with the ring binder on the inside of the drop-spine and permit 100% access to the stored material. Capacity is 50 filing pages.

NAME	FORMAT	RINGS	COLOUR	PACK OF	REF. NO	SUITABLE FOR
Standard A-S Binder	A4	4	Blue Milskin	1	COMA4	Vertical & Hanging A-S Pages, Binder & Security Style A4 Format Pages
Standard A-S Binder	A4	4	Blue Buckram	1	ASCOMA4B	Vertical & Hanging A-S Pages, Binder & Security Style A4 Format Pages
Standard A-S Binder	A3	4	Blue Milskin	1	COMA3	Binder & Security Style A3 Format Pages
Standard A-S Binder	A3	4	Blue Buckram	1	COMA3B	Binder & Security Style A3 Format Pages

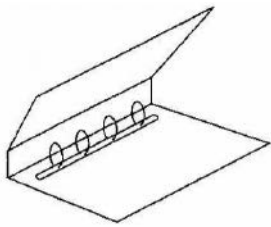

## BINDERS WITH SLIPCASES

Binders with Slipcases are an alternative to the fully enclosed Standard Binders. The high capacity 4-ring binder will accept A-S pages within its 45mm diameter "D" ring mechanism fitted to the back cover.

The archival board is covered with maroon "Milskin" and lined with white barrier paper, whilst a separate slipcase provides all-round protection from light and dust. Capacity is 100 filing pages.

NAME	FORMAT	RINGS	COLOUR	PACK OF	REF. NO	SUITABLE FOR
Binder	A4	4	Maroon	1	BD4RP340300	Filing Pages For Binders & Portfolios, Mounting Systems
Slipcase	A4	-	Maroon	1	SCBD340300	A4 Binder Maroon
Binder	A3	4	Maroon	1	BD4RP460390	Filing Pages For Binders & Portfolios, Mounting Systems.
B.S. Slipcase	A3	-	Maroon	Bespoke	BSA3SC	Bespoke Service.

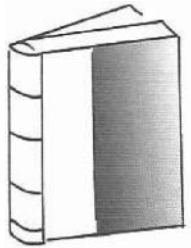

## COLLECTION BINDERS

The Collection Binders are hand-crafted from the finest museum-quality conservation grade materials and bound in attractive dark green library buckram with a contrasting russet colour quarter spine binding and gold lining.

They provide the ideal preservation environment which excludes light, harmful dust and pollution, and help to stabilise temperature and humidity - all important factors in preservation.

With internal barrier lining and high-quality British standard four-ring binder mechanism and the drop-spine design provides easy page access and selection. Capacity is 100 filing pages.

NAME	FORMAT	RINGS	COLOUR	PACK OF	REF. NO	SUITABLE FOR
Collection Binder	A4	4	Green Buckram	1	CCA4B	Filing Pages For Binders & Portfolios and Mounting Systems.
B.S. Collection Binder	A3	4	Green Buckram	1	BSCCA3B	Filing Pages For Binders & Portfolios and Mounting Systems.

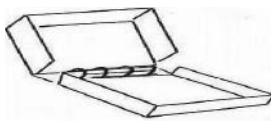

## CERTIFICATE BINDERS

The Certificate System is based on conservation quality and traditional clamshell style binder, and easy access 75 Micron polyester Certificate Pages. The pages are manufactured in a Security Style to facilitate insertion without damage.

The long landscape format clamshell Certificate Binders are made from acid-free museum blue-grey or taupe colour board.

A4 ring binder system is mounted within the box supporting the pages on their long side for ease of viewing and maximum stability.

*For matching Certificate Pages turn to page 9.  
For certificate size of Archival Interleaves without Tabs go to Bespoke Service on page 44.*

NAME	FORMAT	RINGS	COLOUR	PACK OF	REF. NO	SUITABLE FOR
Certificate Binder	440 x 330 x 57mm	4	Blue-Grey	1	GBC	Certificate Pages
Certificate Binder	440 x 330 x 57mm	4	Taupe	1	GBCT	Certificate Pages

## PANORAMIC BINDERS

Panoramic Binders are designed to promote easy access and display without compromising the integrity of the unique source material. The elongated clamshell box offers the perfect acid-free protection in high quality Museum board in grey-blue and taupe colour.

There are three independent ring-binder mechanisms to provide continuous support for crystal clear Panoramic Pages.

The polyester pages are manufactured in a Security Style to facilitate insertion without damage.

*For matching, Panoramic Pages turn to page 9.  
For panoramic size of Archival Interleaves without Tabs go to Bespoke Service on page 44.*

NAME	FORMAT	RINGS	COLOUR	PACK OF	REF. NO	SUITABLE FOR
Panoramic Binder	1250 x 365 x 55mm	12	Blue-Grey	1	SPASB	Panoramic Pages
Panoramic Binder	1250 x 365 x 55mm	12	Taupe	1	SPASBT	Panoramic Pages



## 2 Portfolios



### MINI PORTFOLIO SYSTEM

The Mini Portfolio System provides a perfect presentation solution for 20 images in one neat and portable package. There is a smart 3mm black bookbinding with encloses 4 miniature stainless steel rings and 10 Display Pages for 20 images. Pages are Security Style with a smooth welded edge on 3 sides and the opening on the punched side.

NAME	FORMAT	RINGS	COLOUR	PACK OF	REF. NO	APPLICATION
Mini Portfolio with 10 Pages	A4	4	Black	1	MPA4	Presentation of 20 images in 10 display polyester Pages



### ZIP CASE PORTFOLIOS

The Zip Case Portfolios offer a totally safe and flexible presentation system for prints in A4, A3 and A2 formats.

Handmade in hard wearing solid board finished with Black Library Buckram cloth inside and out they are superbly trimmed with tailored webbing edges and anodized metal corner protectors. A practical retractable handle completes the professional presentation.

Zip Case Portfolios are available with or without 25 pages. Additional packs of 25 or 50 Display Pages for Portfolios are also available.

*Turn to page 8 for Binder & Security Style Pages.*

NAME	FORMAT	DIMENSIONS	RINGS	COLOUR	PACK OF	REF. NO	APPLICATION
Zip Case Portfolio with 25 Pages	A4	350x285x40mm	4	Black Buckram	1	PFA4BKKB	Professional Presentation
Zip Case Portfolio without Pages	A4	350x285x40mm	4	Black Buckram	1	PFA4BKBS	Professional Presentation
Zip Case Portfolio with 25 Pages	A3	465x360x40mm	4	Black Buckram	1	PFA3BKKB	Professional Presentation
Zip Case Portfolio without Pages	A3	465x360x40mm	4	Black Buckram	1	PFA3BKBS	Professional Presentation
Zip Case Portfolio with 25 Pages	A2	645x490x40mm	4	Black Buckram	1	PFA2BKKB	Professional Presentation
Zip Case Portfolio without Pages	A2	645x490x40mm	4	Black Buckram	1	PFA2BKBS	Professional Presentation

## 3 Portfolio Boxes with Pockets & Covers



The Presentation Portfolio Boxes are an alternative to the Mini Portfolio System and Zip Case Portfolios. Boxes are hand-made to conservation standards, from acid-free archival boxboard and covered in hard-wearing library buckram cloth, bonded with neutral pH acrylic adhesive. They are additionally lined with a protective white barrier and feature a double clamshell edge.

When closed, the portfolio box shields prints from light and dust. When opened, the special drop-spine construction allows the box to lay perfectly flat.

Each box portfolio is 38mm deep and comes with 25 pockets or covers in 75 Micron polyester but will accommodate a further 50 items. The strength, clarity and inert chemistry of polyester make them the safest choice for the future longevity of every collection.

Pockets are open on one short side and welded on the other three, while covers are welded on two adjacent sides with a shape of an L and open on the other two. Pockets and Covers are not punched.

Portfolio Boxes are available in black, white, blue, red, green and many other colours. Please feel free to contact us to choose any required colours.

*For a Request Form turn to page 47.*

NAME	DIMENSIONS	RINGS	COLOUR	PACK OF	REF. NO	APPLICATION
A4 Box with 25 Pockets	240x315x38mm	NONE	Various	1	BFA4BKKB	Presentation of images in 25 Pockets
A4 Box With 25 Covers	240x315x38mm	NONE	Various	1	BFCA4BKKB	Presentation of images in 25 Covers
A3 Box With 25 Pockets	318x435x38mm	NONE	Various	1	BFA3BKKB	Presentation of images in 25 Pockets
A3 Box With 25 Covers	318x435x38mm	NONE	Various	1	BFCA3BKKB	Presentation of images in 25 Covers

## II Filing Pages for Binders & Portfolios

The Filing Pages for Binders & Portfolios are acid-free with proven archival safety, superb clarity and strength.

They are manufactured in three styles:

1. Binder Style Files have a separate binding and punched edge with an access to material from the top. Standard A-S Vertical Pages are manufactured in that style except AS203S4SE and AS204S7SE which are open from the outside edge.
2. Security Style Files are open along the punched edge. Material is secure on all sides when placed in a binder. Certificate, Panoramic and Display Pages for Portfolios are manufactured in Security Style.
3. Hanging Style Files have a separate binding edge and an access to material from that edge. When Hanging Bars are placed into the punched edge, files can be used in conventional cabinets or the Secol Hanging File Storage Unit. Hanging Style Files also adequately fit our range of Binders & Portfolios.

All pages are a standard 260mm x 317mm overall with 4 holes. All pockets' dimensions are given with the open dimension first.

Polyester Pages are available in a wide range of pockets' dimensions as bespoke service.

*For a Request Form turn to page 47.*

*For A4 Inserts, and Strips go to Mounting Solutions on page 40.*

*For the Archival Interleaves to provide a protective and visual barrier between pages or sections turn to page 42.*

### 1 Standard A-S Vertical A4 Format Pages

The Standard A-S Vertical A4 Format Pages are produced from exclusive high-clarity, chemically inert polyester material. Uniquely, they protect not only against handling damage such as dirt and fingerprint marking, but most importantly against chemical damage and rapid deterioration caused by acidic attack, present not only in the atmosphere, but particularly in ordinary storage materials including many plastics and especially PVC.

Pages provide also long-term protection against fading and colour loss, yellowing, embrittlement, and eventual destruction.

A comprehensive range of page designs allows the system to be tailored to suit a diverse range of items and a one standard A4 overall page size ensures the uniformity of storage as collections are extended.

*For Hanging AS A4 Format Pages turn to page 10.*

*For Binders and Portfolios turn to page 4.*

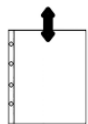

NAME	FORMAT	INTERNAL DIMENSIONS	PACK OF	REF. NO	APPLICATION
<b>1 POCKET</b>					
AS 1 Pocket Pages	260x317mm	1 pocket 233x303mm	25	AS200P1SEQ	A4 format Documents, prints etc.
AS 1 Pocket Pages	260x317mm	1 pocket 233x303mm	50	AS200P1SE	A4 format Documents, prints etc.

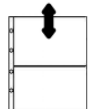

<b>2 POCKETS</b>					
AS 2 Pockets Pages	260x317mm	2 pockets 233x154mm	25	AS201P2SEQ	A5, Notes, Covers, Pamphlets etc.
AS 2 Pockets Pages	260x317mm	2 pockets 233x154mm	50	AS201P2SE	A5, Notes, Covers, Pamphlets etc.

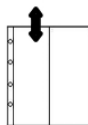

AS 2 Strip Pockets Pages	260x317mm	2 pockets 116x303mm	25	AS211P2SEQ	Prints, 60mm negatives etc.
AS 2 Strip Pockets Pages	260x317mm	2 pockets 116x303mm	50	AS211P2SE	Prints, 60mm negatives etc.

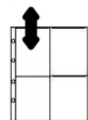

NAME	FORMAT	INTERNAL DIMENSIONS	PACK OF	REF. NO	APPLICATION
<b>4 POCKETS</b>					
AS 4 Pockets Pages	260x317mm	4 pockets 116x154mm	25	AS202P4SEQ	Cards, Tickets etc.
AS 4 Pockets Pages	260x317mm	4 pockets 116x154mm	50	AS202P4SE	Cards, Tickets etc.



AS 4 Strip Pockets Pages	260x317mm	4 pockets 75x230mm	25	AS203S4SEQ	60mm/120 film strips etc.
AS 4 Strip Pockets Pages	260x317mm	4 pockets 75x230mm	50	AS203S4SE	60mm/120 film strips etc.

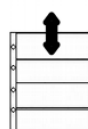

<b>AS 4 STRIP FULL-WIDTH OPEN</b>					
Pockets Pages	260x317mm	4 pockets 230x75mm	25	AS300P4FWQ	60mm /120 film strips etc.
Pockets Pages	260x317mm	4 pockets 230x75mm	50	AS300P4FW	60mm/120 film strips etc.

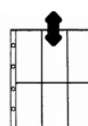

<b>6 POCKETS</b>					
AS 6 Pockets Pages	260x317mm	6 pockets 75x140mm	25	AS212P6Q	Prints, Negatives
AS 6 Pockets Pages	260x317mm	6 pockets 75x140mm	50	AS212P6	Prints, Negatives

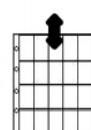
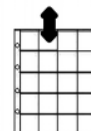
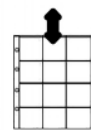
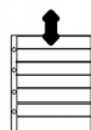

NAME	FORMAT	INTERNAL DIMENSIONS	PACK OF	REF. NO	APPLICATION
<b>7 POCKETS</b> AS 7 Strip Pockets Pages	260x317mm	7 pockets: 42x230mm	25	AS204S7SEQ	35mm Film Strips
AS 7 Strip Pockets Pages	260x317mm	7 pockets: 42x230mm	50	AS204S7SE	35mm Film Strips
<b>AS 7 STRIP FULL-WIDTH OPEN</b> Pockets Pages	260x317mm	7 pockets 230x42mm	25	AS301P7FWQ	35mm Film Strips
Pockets Pages	260x317mm	7 pockets 230x42mm	50	AS301P7FW	35mm Film Strips
<b>12 POCKETS</b> AS 12 Pockets Pages	260x317mm	12 pockets 76x66mm	25	AS207P12SEQ	6 x 6 and 6 x 7cm Frames, Images
AS 12 Pockets Pages	260x317mm	12 pockets 76x66mm	50	AS207P12SE	6 x 6 and 6 x 7cm Frames, Images
<b>20 POCKETS</b> AS 20 Pockets Pages	260x317mm	20 pockets 57x54mm	25	AS205P20SEQ	35mm Slides, Tickets, Coins
AS 20 Pockets Pages	260x317mm	20 pockets 57x54mm	50	AS205P20SE	35mm Slides, Tickets, Coins
AS 20 Cigarette Pockets Page	260x317mm	20 Pockets 43x65mm	25	AS208P20SEQ	Cigarette Cards, Tickets
AS 20 Cigarette Pockets Page	260x317mm	20 Pockets 43x65mm	50	AS208P20SE	Cigarette Cards, Tickets
B.S AS Pockets Pages	260x317mm	Bespoke Service	25	BSAS2PSEQ	Bespoke Service
B.S AS Pockets Pages	260x317mm	Bespoke Service	50	BSAS2PSE	Bespoke Service

## 2 Binder Style Display Pages

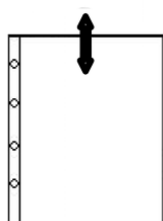

Binder Style Pages are manufactured from glass-clear archival 75 Micron Polyester film. They display and enhance material with exceptional clarity, sharpness and colour rendition.

Pages are punched with 4 holes with a smooth welded edge on 3 sides and opening on the top edge.

Binder Style Pages are ideal if material is regularly replaced. All pages' dimensions are given with the open dimension first.

*For Binders and Portfolios turn to page 4.*

NAME	OVERALL DIMENSION	INTERNAL DIMENSIONS	PACK OF	REF NO	APPLICATION
Binder Style Pages A4	240x305mm	220x305mm	25	P1A4BE4Y75SSQ	Display of prints, documents etc.
Binder Style Pages A4	240x305mm	220x305mm	50	P1A4BE4Y75SS	Display of prints, documents etc.
Binder Style Pages A3	330x425mm	310x425mm	25	P1A3BE4Y75SSQ	Display of prints, documents etc.
Binder Style Pages A3	330x425mm	310x425mm	50	P1A3BE4Y75SS	Display of prints, documents etc.

## 3 Security Style Display Pages

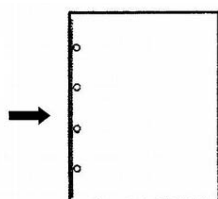

Security Style Pages are manufactured from glass-clear archival 75 Micron Polyester film. They are punched with 4 holes but opened along the punched edge to keep material secure on all sides when placed in the Secol Binders or Portfolios.

Security Style Pages are ideal when contents are changed infrequently. They display and enhance material with exceptional clarity, sharpness and colour rendition. Packs of 10 Security Style Pages are available as bespoke service.

NAME	OVERALL DIMENSION	INTERNAL DIMENSIONS	PACK OF	REF NO	APPLICATION
Security Style Pages A4	310x240mm	310x220mm	25	P1A4SC4Y75LSQ	Display of prints, documents etc.
Security Style Pages A4	310x240mm	310x220mm	50	P1A4SC4Y75LS	Display of prints, documents etc.



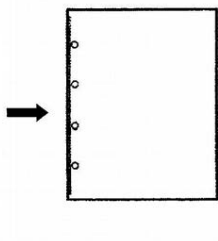

NAME	OVERALL DIMENSION	INTERNAL DIMENSIONS	PACK OF	REF NO	APPLICATION
Security Style Pages A3	430x340mm	430x320mm	25	P1A3SC4Y75LSQ	Display of prints, documents etc.
Security Style Pages A3	430x340mm	430x320mm	50	P1A3SC4Y75LS	Display of prints, documents etc.
Security Style Pages A2	604x442mm	604x422mm	25	P1A2SC4Y75LSQ	Display of prints, documents etc.
Security Style Pages A2	604x442mm	604x422mm	50	P1A2SC4Y75LS	Display of prints, documents etc.
B. S. Security Style Pages A4	310x240mm	310x220mm	10	BSP1A4SC4Y75LSX	Display of prints, documents etc.
B. S. Security Style Pages A3	430x340mm	430x320mm	10	BSP1A3SC4Y75LSX	Display of prints, documents etc.
B. S. Security Style Pages A2	604x442mm	604x422mm	10	BSP1A2SC4Y75LSX	Display of prints, documents etc.

## 4 Certificate Pages

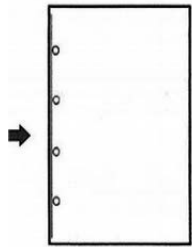

Certificate Pages are manufactured from glass-clear archival 75 Micron Polyester film. Exclusive high-clarity, strength, chemically inert Polyester material provides long-term protection against fading and colour loss, yellowing etc.

Certificate Pages are punched with 4 holes but open along the punched edge to keep material secure on all sides when placed in the Certificate Binder.

Pages provide a safe way of storing the elongated traditional certificates of Births, Marriages and Deaths.

They are also useful for panoramic prints, Charts and other outside formats. All pages' dimensions are given with the open dimension first.

*For Certificate Binders turn to page 5.*

NAME	OVERALL DIMENSION	PACK OF	REF NO	SUITABLE FOR/APPLICATION
Certificate Pages	400x260mm	10	P1SC400260Y75X	Certificate Binders/ Traditional certificates of Births, Marriages and Deaths
Certificate Pages	400x260mm	25	P1SC400260Y75	Certificate Binders/Traditional certificates of Births, Marriages and Deaths

## 5 Panoramic Pages

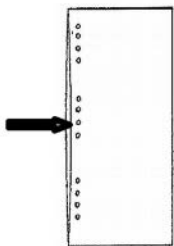

Panoramic Pages are manufactured from glass-clear archival 75 Micron Polyester film. Exclusive high-clarity, strength, chemically inert

Pages are design to store Panoramic Photographs and Prints back-to-back. Pages can be arranged in a properly indexed and chronological order and browsed like a book without danger or contamination of ungloved hands.

All pages' dimensions are given with the open dimension first.

*For Panoramic Binders turn to page 5.*

*For Mounting Solutions do to page 40.*

*For archival Interleaves, Index Cards and Labels go to Accessories on page 42.*

NAME	OVERALL DIMENSION	PACK OF	REF NO	APPLICATION	SUITABLE FOR/APPLICATION
Panoramic Pages	1200x310mm	10	SPASP	Panoramic Photographs and Prints	Panoramic Binders/ Panoramic Photographs, prints

## 6 Hanging A-S A4 Format Pages

Hanging A-S A4 Format Pages are produced from exclusive high-clarity, chemically inert polyester material. Files can be used in conventional cabinets or the flexible individual Secol Handling File Storage Unit which provides a great benefit of portability to every section.

They are punched with 4 holes and also fit Secol A4 Format Binders & Portfolios. With the opening along the separate punched binding edge Hanging Pages bring the solution for security and easy accessibility to a storage material. All Hanging AS Pages are a standard 317 x 260mm overall. All pockets' dimensions are given with the open dimension first.

*For Hanging File Storage System turn to page 12 .*

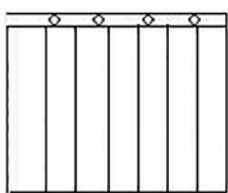
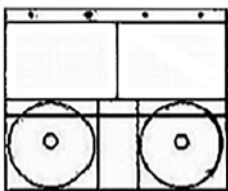
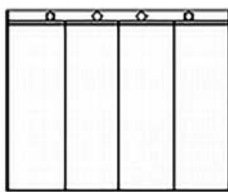
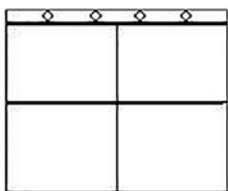
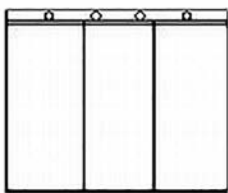
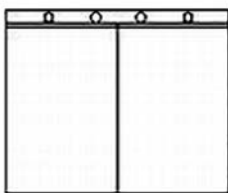
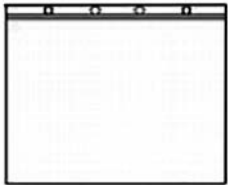

NAME	OVERALL DIMENSION	INTERNAL DIMENSIONS	PACK OF	REF NO	APPLICATION
Hanging A-S 1 Pocket Pages	317x260mm	1 pocket 309x230mm	10	AS100P1X	A4 format documents, Mounting Inserts
Hanging A-S 1 Pocket Pages	317x260mm	1 pocket 309x230mm	25	AS100P1Q	A4 format Documents, Mounting Inserts
Hanging A-S 1 Pocket Pages	317x260mm	1 pocket 309x230mm	50	AS100P1	A4 format Documents, Mounting Inserts
Hanging A-S 2 Pockets Pages	317x260mm	2 pockets 154x230mm	10	AS101P2X	A5 format documents, prints,
Hanging A-S 2 Pockets Pages	317x260mm	2 pockets 154x230mm	25	AS101P2Q	A5 format documents, prints,
Hanging A-S 2 Pockets Pages	317x260mm	2 pockets 154x230mm	50	AS101P2	A5 format documents, prints,
Hanging A-S 3 Pockets Pages	317x260mm	3 pockets 102x230mm	10	AS108P3X	Stereos, 9x4" prints, panoramas
Hanging A-S 3 Pockets Pages	317x260mm	3 pockets 102x230mm	25	AS108P3Q	Stereos, 9x4" prints, panoramas
Hanging A-S 3 Pockets Pages	317x260mm	3 pockets 102x230mm	50	AS108P3	Stereos, 9x4" prints, panoramas
Hanging A-S 4 Pockets Pages	317x260mm	4 Pockets 154x113mm	10	AS102P4X	A6 format documents, prints 5x4"
Hanging A-S 4 Pockets Pages	317x260mm	4 Pockets 154x113mm	25	AS102P4Q	A6 format documents, prints 5x4"
Hanging A-S 4 Pockets Pages	317x260mm	4 Pockets 154x113mm	50	AS102P4	A6 format documents, prints 5x4"
Hanging A-S 4 Strip Pockets Pages	317x260mm	4 Pockets 76x230mm	10	AS103S4X	120/60mm film strips
Hanging A-S 4 Strip Pockets Pages	317x260mm	4 Pockets 76x230mm	25	AS103S4Q	120/60mm film strips
Hanging A-S 4 Strip Pockets Pages	317x260mm	4 Pockets 76x230mm	50	AS103S4	120/60mm film strips
2 CD & 2 Index Pockets Pages	317x260mm	2x124x124&2x153x110mm	10	ASCD2X	CD, DVD, Index Cards
2 CD & 2 Index Pockets Pages	317x260mm	2x124x124&2x153x110mm	25	ASCD2Q	CD, DVD, Index Cards
2 CD & 2 Index Pockets Pages	317x260mm	2x124x124&2x153x110mm	50	ASCD2	CD, DVD, Index Cards
Hanging A-S 7 Strip Pockets Pages	317x260mm	7 pockets: 42x230mm	10	AS104S7X	35mm Film Strips
Hanging A-S 7 Strip Pockets Pages	317x260mm	7 pockets: 42x230mm	25	AS104S7Q	35mm Film Strips
Hanging A-S 7 Strip Pockets Pages	317x260mm	7 pockets: 42x230mm	50	AS104S7	35mm Film Strips

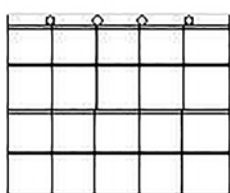
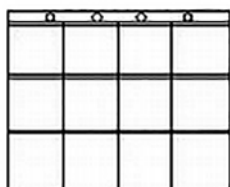
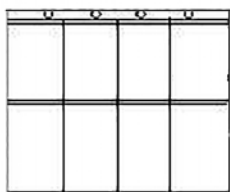

NAME	OVERALL DIMENSION	INTERNAL DIMENSIONS	PACK OF	REF NO	APPLICATION
Hanging A-S 8 Pockets Pages	317x260mm	8 Pockets 76x113mm	10	AS106P8X	Cartes de Visites, Playing Cards
Hanging A-S 8 Pockets Pages	317x260mm	8 Pockets 76x113mm	25	AS106P8Q	Cartes de Visites, Playing Cards
Hanging A-S 8 Pockets Pages	317x260mm	8 Pockets 76x113mm	50	AS106P8	Cartes de Visites, Playing Cards
Hanging A-S 12 Pockets Pages	317x260mm	12 Pockets 76x76mm	10	AS107P12X	Coins, tickets
Hanging A-S 12 Pockets Pages	317x260mm	12 Pockets 76x76mm	25	AS107P12Q	Coins, tickets
Hanging A-S 12 Pockets Pages	317x260mm	12 Pockets 76x76mm	50	AS107P12	Coins, tickets
Hanging A-S 20 Pockets Pages	317x260mm	20 Pockets 60x54mm	10	AS105P20X	35mm mounted slides
Hanging A-S 20 Pockets Pages	317x260mm	20 Pockets 60x54mm	25	AS105P20Q	35mm mounted slides
Hanging A-S 20 Pockets Pages	317x260mm	20 Pockets 60x54mm	50	AS105P20	35mm mounted slides

### III Hanging File Storage System

The Secol Archival quality Hanging System offers a highly space efficient and easily indexed means of archiving large quantities of material with the benefit of portability to individual sections of collections.

Hanging File Storage Unit uniquely combining the advantages of fixed Hanging Files and portable binder systems in a free-standing box. The flip top lid opens in conjunction with protective front drop-flap to provide ready access to the files inside. Each unit holds about 50 hanging files.

Hanging File Flysheets provide extra protection where hanging files are accessed regularly. These neat polyester sheets fit all 247x350mm files, and are supplied with an acrylic adhesive strip for easy application along the top of edge of the file.

Hanging Bars are supplied in standard format with anti-friction coating at each end.

Index Tabs are clear polyester material complete with adhesive strip and paper insert for permanent indexing of the collection.

Hanging A-S A4 Format Pages and Wide Format Hanging Files are manufactured from acid-free polyester to provide proven long-term archival storage.

For Hanging A-S A4 Format Pages turn to page 10.

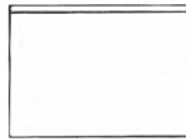
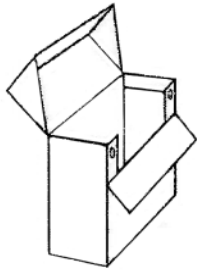

NAME	DIMENSIONS	PACK OF	REF. NO	SUITABLE FOR/APPLICATION
Hanging File Storage Unit	415x317x75mm	1	HFB415317D75	Archiving/Hanging Files
Hanging Bars	406mm	10	HB13406BE/10	Hanging Files, Hanging Unit
Index Tabs Inc Labels	20x52mm	50	IT5020	Hanging Files/Indexing
Hanging File FlySheets	245x350mm	10	FS245350AST6Y75	Hanging Files, Hanging Unit/Extra Protection

#### 1 Wide Format Hanging Files

Wide Format Hanging Files offer long-term archival safety and protection against physical damage, surface reaction and atmospheric contamination and with the superb clarity of window glass, they offer unsurpassed optical rendition to the viewer. They are available as Clear or with frosted back as Colourview files.

Wide Files have no holes. They are suitable for Hanging File Storage Unit with the usage of Hanging Bars.

Formats 247 x 350mm wide are available as 1 pocket, 2, 12 and 24 packets files. Format 220 x 370mm wide is available as 8 pocket file.

In specifying dimensions of items listed below the open side is always the first dimension.

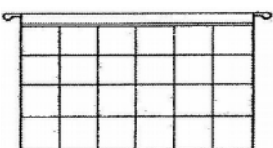
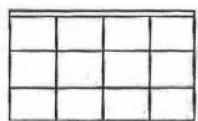
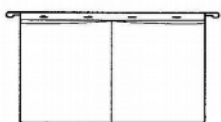
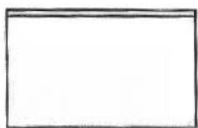

NAME	DIMENSIONS	REF. NO	SUITABLE FOR/APPLICATION
Wide Format 1 Pocket Files/Clear	247x350mm/8¼x13¼"	HF1P8281348T/10	Hanging File Unit/Foolscap
Wide Format 1 Pocket Files/Colourview	247x350mm/8¼x13¼"	HF1P8281348C/10	Hanging File Unit/Foolscap
Wide Format 2 Pockets Files/Clear	247x350mm/2 x 170x212mm	HF2P648848T/10	Hanging File Unit/ 170x212mm material
Wide Format 2 Pockets Files/Colourview	247x350mm/2 x 170x212mm	HF2P648848C/10	Hanging File Unit/ 170x212mm material
Wide Format 8 Pockets Files/Clear	220x370mm/8 x 90x76mm	HF8P67MT/10	Hanging File Unit/ 90x76mm material
Wide Format 8 Pockets Files/Colourview	220x370mm/8 x 90x76mm	HF8P67MC/10	Hanging File Unit/ 90x76mm material
Wide Format 12 Pockets Files/Clear	247x350mm/12 x 79x64mm	HF12P228T/10	Hanging File Unit/6 x 6 slides, 79x64mm material
Wide Format 12 Pockets Files/Colourview	247x350mm/12 x 79x64mm	HF12P228C/10	Hanging File Unit/6 x 6 slides, 79x64mm material
Wide Format 24 Pockets Files/Clear	247x350mm/24 x 54x49mm	HF24P35MT/10	Hanging File Unit /35mm mounted slides, 79x64mm material
Wide Format 24 Pockets Files/Colourview	247x350mm/24 x 54x49mm	HF24P35MC/10	Hanging File Unit /35mm mounted slides, 79x64mm material

## IV Polyester Pockets, Covers & Folders

The Secol Standard Pockets, Covers & Folders are manufactured from Polyester film that provides the highest clarity, optical rendition and protective strength.

They are not punched with any holes and will fit the wide range of acid-free Boxes.

They are available in a wide range of formats, but if the size you require is not listed please feel free to contact us.

*For a Request Form turn to page 47.*

*For wide range of polyester Sleeves and Sleeve Rolls turn to page 23.*

*For Pockets with filing holes go to Filing Pages For Binders & Portfolios on page 7.*

*For A4 Inserts, and Strips go to Mounting Solutions on page 40.*

*For Gloves, Labels, Marker Pens etc. go to Accessories on page 42.*

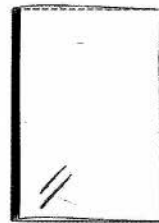
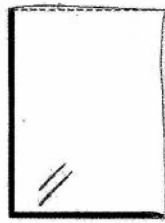
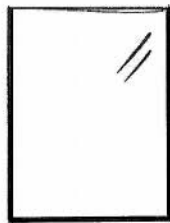
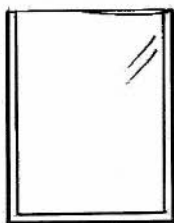

### 1 Comprehensive "HC" Archival Pockets

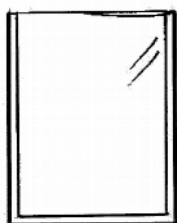

The Comprehensive Archival Pockets enable extensive collections to be protected and stored economically. Polyester "HC" material is completely inert and acid free which means absolutely safe for photographic and paper protection.

They also offer colour rendition and display properties which are difficult to fault. Pockets are ideal for long term storage of documents, postcards, ink jet prints, photographs and any other paper or photographic material. Available in most popular sizes they can be also manufactured in various dimensions and a quantity to meet different requirements. In specifying dimensions the open side is always the first dimension.

DESCRIPTION	DIMENSIONS	PACK OF	REF NO	APPLICATION	SUITABLE FOR
Comprehensive Archival Pockets	108x134mm	50	HCP108134	5x4" film	Acid-free Boxes
Comprehensive Archival Pockets	108x134mm	100	HCP108134M	5x4" film	Acid-free Boxes
Comprehensive Archival Pockets	127x172mm	50	HCP127172	CD, DVD	Acid-free Boxes
Comprehensive Archival Pockets	127x172mm	100	HCP127172M	CD, DVD	Acid-free Boxes
Comprehensive Archival Pockets	134x184mm	50	HCP134184	5x7" prints	Acid-free Boxes
Comprehensive Archival Pockets	134x184mm	100	HCP134184M	5x7" prints	Acid-free Boxes
Comprehensive Archival Pockets	185x185mm	50	HCP185185	Single vinyl	Acid-free Boxes
Comprehensive Archival Pockets	185x185mm	100	HCP185185M	Single vinyl	Acid-free Boxes
Comprehensive Archival Pockets	210x260mm	50	HCP210260	8x10" prints	Acid-free Boxes
Comprehensive Archival Pockets	210x260mm	100	HCP210260M	8x10" prints	Acid-free Boxes
Comprehensive Archival Pockets	220x305mm	50	HCP220305	A4 format prints, cuts, documents	Acid-free Boxes, Mounting inserts
Comprehensive Archival Pockets	220x305mm	100	HCP220305M	A4 format prints, cuts, documents	Acid-free Boxes, Mounting inserts
Comprehensive Archival Pockets	260x312mm	50	HCP260312	10x12" prints	Acid-free Boxes
Comprehensive Archival Pockets	260x312mm	100	HCP260312M	10x12" prints	Acid-free Boxes
Comprehensive Archival Pockets	310x310mm	50	HCP310310	LP vinyl	Acid-free Boxes
Comprehensive Archival Pockets	310x310mm	100	HCP310310M	LP vinyl	Acid-free Boxes

## 2 STANDARD POLYESTER POCKETS



The Secol Standard Polyester Pockets are open on one short side and welded on the other three sides. They are not punched with any holes.

They supply a totally safe and reliable enclosure for the most precious and vulnerable of materials. In specifying dimensions of items the open site

is always the first dimension. Pockets are available in packs of 25 and 50 apart from Standard O.S. map and A0 formats which are available in packs of 10

The most popular formats (A4, A3, A2 and A1) of 75 Micron pockets, are also available in packs of 10.

NAME	DIMENSIONS	FORMAT	CATEGORY	PACK OF	REF. NO	APPLICATION
Standard Pockets	76x112mm	3x4½"	50 Micron Polyester	25	P176112Y50Q	Cartes de Visite etc
Standard Pockets	76x112mm	3x4½"	50 Micron Polyester	50	P176112Y50	Cartes de Visite etc.
Standard Pockets	76x112mm	3x4½"	75 Micron Polyester	25	P176112Y75Q	Cartes de Visite etc.
Standard Pockets	76x112mm	3x4½"	75 Micron Polyester	50	P176112Y75	Cartes de Visite etc.
Standard Pockets	76x152mm	3x6"	50 Micron Polyester	25	P176152Y50Q	3x6" prints, pictures, etc.
Standard Pockets	76x152mm	3x6"	50 Micron Polyester	50	P176152Y50	3x6" prints, pictures etc.
Standard Pockets	76x152mm	3x6"	75 Micron Polyester	25	P176152Y75Q	3x6" prints, pictures, etc.
Standard Pockets	76x152mm	3x6"	75 Micron Polyester	50	P176152Y75	3x6" prints, pictures etc.
Standard Pockets	108x134mm	5x4"	50 Micron Polyester	25	P1108134Y50Q	5x4" prints, pictures, etc.
Standard Pockets	108x134mm	5x4"	50 Micron Polyester	50	P1108134Y50	5x4" prints, pictures, etc.
Standard Pockets	108x134mm	5x4"	75 Micron Polyester	25	P1108134Y75Q	5x4" prints, pictures, etc.
Standard Pockets	108x134mm	5x4"	75 Micron Polyester	50	P1108134Y75	5x4" prints, pictures, etc.
Standard Pockets	115x155mm	A6	50 Micron Polyester	25	PIA6Y50Q	4.5x6" prints, pictures, etc.
Standard Pockets	115x155mm	A6	50 Micron Polyester	50	PIA6Y50	4.5x6" prints, pictures, etc.
Standard Pockets	115x155mm	A6	75 Micron Polyester	25	PIA6Y75Q	4.5x6" prints, pictures, etc.
Standard Pockets	115x155mm	A6	75 Micron Polyester	50	PIA6Y75	4.5x6" prints, pictures, etc.
Standard Pockets	127x127mm	CD	50 Micron Polyester	25	P1127127Y50Q	CD, DVD
Standard Pockets	127x127mm	CD	50 Micron Polyester	50	P1127127Y50	CD, DVD
Standard Pockets	127x127mm	CD	75 Micron Polyester	25	P1127127Y75Q	CD, DVD
Standard Pockets	127x127mm	CD	75 Micron Polyester	50	P1127127Y75	CD, DVD
Standard Pockets	127x127mm	CD	100 Micron Polyester	25	P1127127Y100Q	CD, DVD
Standard Pockets	127x127mm	CD	100 Micron Polyester	50	P1127127Y100	CD, DVD
Standard Pockets	134x184mm	5x7"	50 Micron Polyester	25	P1134184Y50Q	5x7" prints, pictures, etc.
Standard Pockets	134x184mm	5x7"	50 Micron Polyester	50	P1134184Y50	5x7" prints, pictures, etc.
Standard Pockets	134x184mm	5x7"	75 Micron Polyester	25	P1134184Y75Q	5x7" prints, pictures, etc.
Standard Pockets	134x184mm	5x7"	75 Micron Polyester	50	P1134184Y75	5x7" prints, pictures, etc.
Standard Pockets	134x184mm	5x7"	100 Micron Polyester	25	P1134184Y100Q	5x7" prints, pictures, etc.
Standard Pockets	134x184mm	5x7"	100 Micron Polyester	50	P1134184Y100	5x7" prints, pictures, etc.
Standard Pockets	152x203mm	Foolscap Quarto	50 Micron Polyester	25	P1152203Y50Q	6.5x8" prints, pictures, etc.
Standard Pockets	152x203mm	Foolscap Quarto	50 Micron Polyester	50	P1152203Y50	6.5x8" prints, pictures, etc.
Standard Pockets	152x203mm	Foolscap Quarto	75 Micron Polyester	25	P1152203Y75Q	6.5x8" prints, pictures, etc.
Standard Pockets	152x203mm	Foolscap Quarto	75 Micron Polyester	50	P1152203Y75	6.5x8" prints, pictures, etc.
Standard Pockets	152x203mm	Foolscap Quarto	100 Micron Polyester	25	P1152203Y100Q	6.5x8" prints, pictures, etc.
Standard Pockets	152x203mm	Foolscap Quarto	100 Micron Polyester	50	P1152203Y100	6.5x8" prints, pictures, etc.



NAME	DIMENSIONS	FORMAT	CATEGORY	PACK OF	REF. NO	APPLICATION
Standard Pockets	152x230mm	6x9"	50 Micron Polyester	25	P1152230Y50Q	6x9" prints, pictures, etc.
Standard Pockets	152x230mm	6x9"	50 Micron Polyester	50	P1152230Y50	6x9" prints, pictures etc.
Standard Pockets	152x230mm	6x9"	75 Micron Polyester	25	P1152230Y75Q	6x9" prints, pictures, etc.
Standard Pockets	152x230mm	6x9"	75 Micron Polyester	50	P1152230Y75	6x9" prints, pictures, etc.
Standard Pockets	152x230mm	6x9"	100 Micron Polyester	25	P1152230Y100Q	6x9" prints, pictures, etc.
Standard Pockets	152x230mm	6x9"	100 Micron Polyester	50	P1152230Y100	6x9" prints, pictures, etc.
Standard Pockets	160x215mm	A5	50 Micron Polyester	25	P1A5Y50Q	5.8x8.3" prints, pictures, etc.
Standard Pockets	160x215mm	A5	50 Micron Polyester	50	P1A5Y50	5.8x8.3" prints, pictures, etc.
Standard Pockets	160x215mm	A5	75 Micron Polyester	25	P1A5Y75Q	5.8x8.3" prints, pictures, etc.
Standard Pockets	160x215mm	A5	75 Micron Polyester	50	P1A5Y75	5.8x8.3" prints, pictures, etc.
Standard Pockets	160x215mm	A5	100 Micron Polyester	25	P1A5Y100Q	5.8x8.3" prints, pictures, etc.
Standard Pockets	160x215mm	A5	100 Micron Polyester	50	P1A5Y100	5.8x8.3" prints, pictures, etc.
Standard Pockets	203x330mm	Foolscap Folio	50 Micron Polyester	25	P1203330Y50Q	8.5 x 13.5" prints, pictures, etc.
Standard Pockets	203x330mm	Foolscap Folio	50 Micron Polyester	50	P1203330Y50	8.5 x 13.5" prints, pictures, etc.
Standard Pockets	203x330mm	Foolscap Folio	75 Micron Polyester	25	P1203330Y75Q	8.5 x 13.5" prints, pictures, etc.
Standard Pockets	203x330mm	Foolscap Folio	75 Micron Polyester	50	P1203330Y75	8.5 x 13.5" prints, pictures, etc.
Standard Pockets	203x330mm	Foolscap Folio	100 Micron Polyester	25	P1203330Y100Q	8.5 x 13.5" prints, pictures, etc.
Standard Pockets	203x330mm	Foolscap Folio	100 Micron Polyester	50	P1203330Y100	8.5 x 13.5" prints, pictures, etc.
Standard Pockets	210x258mm	8x10"	50 Micron Polyester	25	P1210254Y50Q	8x10" prints, pictures, etc.
Standard Pockets	210x258mm	8x10"	50 Micron Polyester	50	P1210254Y50	8x10" prints, pictures, etc.
Standard Pockets	210x258mm	8x10"	75 Micron Polyester	25	P1210254Y75Q	8x10" prints, pictures, etc.
Standard Pockets	210x258mm	8x10"	75 Micron Polyester	50	P1210254Y75	8x10" prints, pictures, etc.
Standard Pockets	210x258mm	8x10"	100 Micron Polyester	25	P1210254Y100Q	8x10" prints, pictures, etc.
Standard Pockets	210x258mm	8x10"	100 Micron Polyester	50	P1210254Y100	8x10" prints, pictures, etc.
Standard Pockets	220x305mm	A4	50 Micron Polyester	25	P1A4Y50Q	8.3x11.7" prints, documents, etc.
Standard Pockets	220x305mm	A4	50 Micron Polyester	50	P1A4Y50	8.3x11.7" prints, documents, etc.
Standard Pockets	220x305mm	A4	75 Micron Polyester	10	P1A4Y75X	8.3x11.7" prints, documents, etc.
Standard Pockets	220x305mm	A4	75 Micron Polyester	25	P1A4Y75Q	8.3x11.7" prints, documents, etc.
Standard Pockets	220x305mm	A4	75 Micron Polyester	50	P1A4Y75	8.3x11.7" prints, documents, etc.
Standard Pockets	220x305mm	A4	100 Micron Polyester	25	P1A4Y100Q	8.3x11.7" prints, documents, etc.
Standard Pockets	220x305mm	A4	100 Micron Polyester	50	P1A4Y100	8.3x11.7" prints, documents, etc.
Standard Pockets	230x305mm	9x12"	50 Micron Polyester	25	P1230305Y50Q	9x12" prints, pictures, etc.
Standard Pockets	230x305mm	9x12"	50 Micron Polyester	50	P1230305Y50	9x12" prints, pictures, etc.
Standard Pockets	230x305mm	9x12"	75 Micron Polyester	25	P1230305Y75Q	9x12" prints, pictures, etc.
Standard Pockets	230x305mm	9x12"	75 Micron Polyester	50	P1230305Y75	9x12" prints, pictures, etc.
Standard Pockets	230x305mm	9x12"	100 Micron Polyester	25	P1230305Y100Q	9x12" prints, pictures, etc.
Standard Pockets	230x305mm	9x12"	100 Micron Polyester	50	P1230305Y100	9x12" prints, pictures, etc.
Standard Pockets	260x305mm	10x12"	50 Micron Polyester	25	P1260305Y50Q	12x10" prints, pictures, etc.
Standard Pockets	260x305mm	10x12"	50 Micron Polyester	50	P1260305Y50	12x10" prints, pictures, etc.
Standard Pockets	260x305mm	10x12"	75 Micron Polyester	25	P1260305Y75Q	12x10" prints, documents, etc.
Standard Pockets	260x305mm	10x12"	75 Micron Polyester	50	P1260305Y75	12x10" prints, documents, etc.
Standard Pockets	260x305mm	10x12"	100 Micron Polyester	25	P1260305Y100Q	12x10" prints, documents, etc.
Standard Pockets	260x305mm	10x12"	100 Micron Polyester	50	P1260305Y100	12x10" prints, documents, etc.

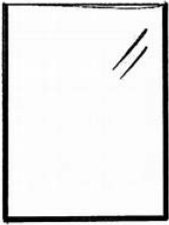

NAME	DIMENSIONS	FORMAT	CATEGORY	PACK OF	REF. NO	APPLICATION
Standard Pockets	267x381mm	Quarter Imperial	75 Micron Polyester	25	P1267381Y75Q	Quarter Imperial prints, etc.
Standard Pockets	267x381mm	Quarter Imperial	75 Micron Polyester	50	P1267381Y75	Quarter Imperial prints, etc.
Standard Pockets	267x381mm	Quarter Imperial	100 Micron Polyester	25	P1267381Y100Q	Quarter Imperial prints, etc.
Standard Pockets	267x381mm	Quarter Imperial	100 Micron Polyester	50	P1267381Y100	Quarter Imperial prints, etc.
Standard Pockets	305x381mm	12x15"	75 Micron Polyester	25	P1305381Y75Q	12x 15" prints, etc.
Standard Pockets	305x381mm	12x15"	75 Micron Polyester	50	P1305381Y75	12x 15" prints, etc.
Standard Pockets	305x381mm	12x15"	100 Micron Polyester	25	P1305381Y100Q	12x 15" prints, etc.
Standard Pockets	305x381mm	12x15"	100 Micron Polyester	50	P1305381Y100	12x 15" prints, etc.
Standard Pockets	310x425mm	A3	75 Micron Polyester	10	P1A3Y75X	12 1/8x 16 5/8" prints, documents, etc.
Standard Pockets	310x425mm	A3	75 Micron Polyester	25	P1A3Y75Q	12 1/8x 16 5/8" prints, documents, etc.
Standard Pockets	310x425mm	A3	75 Micron Polyester	50	P1A3Y75	12 1/8x 16 5/8" prints, documents, etc.
Standard Pockets	310x425mm	A3	100 Micron Polyester	25	P1A3Y100Q	12 1/8x 16 5/8" prints, documents, etc.
Standard Pockets	310x425mm	A3	100 Micron Polyester	50	P1A3Y100	12 1/8x 16 5/8" prints, documents, etc.
Standard Pockets	335x488mm	A3+	75 Micron Polyester	25	P1335488Y75Q	13¼x 19¼" prints, documents, etc.
Standard Pockets	335x488mm	A3+	75 Micron Polyester	50	P1335488Y75	13¼x 19¼" prints, documents, etc.
Standard Pockets	335x488mm	A3+	100 Micron Polyester	25	P1335488Y100Q	13¼x 19¼" prints, documents, etc.
Standard Pockets	335x488mm	A3+	100 Micron Polyester	50	P1335488Y100	13¼x 19¼" prints, documents, etc.
Standard Pockets	386x531mm	Half Imperial	75 Micron Polyester	25	P1386531Y75Q	15x22" prints, pictures, etc.
Standard Pockets	386x531mm	Half Imperial	75 Micron Polyester	50	P1386531Y75	15x22" prints, pictures, etc.
Standard Pockets	386x531mm	Half Imperial	100 Micron Polyester	25	P1386531Y100Q	15x22" prints, pictures, etc.
Standard Pockets	386x531mm	Half Imperial	100 Micron Polyester	50	P1386531Y100	15x22" prints, pictures, etc.
Standard Pockets	412x508mm	16¼x 20"	75 Micron Polyester	25	P1412508Y75Q	16x20" prints, pictures, etc.
Standard Pockets	412x508mm	16¼x 20"	75 Micron Polyester	50	P1412508Y75	16x20" prints, pictures, etc.
Standard Pockets	412x508mm	16¼x 20"	100 Micron Polyester	25	P1412508Y100Q	16x20" prints, pictures, etc.
Standard Pockets	412x508mm	16¼x 20"	100 Micron Polyester	50	P1412508Y100	16x20" prints, pictures, etc.
Standard Pockets	430x600mm	A2	75 Micron Polyester	10	P1A2Y75X	16 7/8x 23½" prints, pictures, etc.
Standard Pockets	430x600mm	A2	75 Micron Polyester	25	P1A2Y75Q	16 7/8x 23½" prints, pictures, etc.
Standard Pockets	430x600mm	A2	75 Micron Polyester	50	P1A2Y75	16 7/8x 23½" prints, pictures, etc.
Standard Pockets	430x600mm	A2	100 Micron Polyester	25	P1A2Y100Q	16 7/8x 23½" prints, pictures, etc.
Standard Pockets	430x600mm	A2	100 Micron Polyester	50	P1A2Y100	16 7/8x 23½" prints, pictures, etc.
Standard Pockets	521x725mm	20½x 28½"	75 Micron Polyester	25	P1521725Y75Q	20½x 28½" prints, pictures, etc.
Standard Pockets	521x725mm	20½x 28½"	75 Micron Polyester	50	P1521725Y75	20½x 28½" prints, pictures, etc.
Standard Pockets	521x725mm	20½x 28½"	100 Micron Polyester	25	P1521725Y100Q	20½x 28½" prints, pictures, etc.
Standard Pockets	521x725mm	20½x 28½"	100 Micron Polyester	50	P1521725Y100	20½x 28½" prints, pictures, etc.
Standard Pockets	605x845mm	A1	75 Micron Polyester	10	P1A1Y75X	23¼x 33¼" prints, posters, etc.
Standard Pockets	605x845mm	A1	75 Micron Polyester	25	P1A1Y75Q	23¼x 33¼" prints, posters, etc.
Standard Pockets	605x845mm	A1	75 Micron Polyester	50	P1A1Y75	23¼x 33¼" prints, posters, etc.
Standard Pockets	605x845mm	A1	100 Micron Polyester	25	P1A1Y100Q	23¼x 33¼" prints, posters, etc.
Standard Pockets	605x845mm	A1	100 Micron Polyester	50	P1A1Y100	23¼x 33¼" prints, posters, etc.
Standard Pockets	775x1025mm	Standard O.S. map	100 Micron Polyester	10	P17751025Y100	30½x 40¼" Standard O.S. map
Standard Pockets	857x1207mm	A0	100 Micron Polyester	10	P18571207Y100	33¼"x 47½" A0 Maps, posters etc.



### 3 STANDARD POLYESTER COVERS

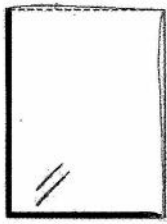

The Secol Standard Polyester Covers are completely inert and acid-free. They are ideal for photographic and paper long-term archival storage. Covers are welded on two adjacent sides with a shape of an L and open on the other two for easy access to surface. They are not punched.

NAME	DIMENSIONS	FORMAT	CATEGORY	PACK OF	REF. NO	APPLICATION
Standard Covers	76x112mm	3x4½"	50 Micron Polyester	25	C76112Y50Q	Cartes de Visite etc.
Standard Covers	76x112mm	3x4½"	50 Micron Polyester	50	C76112Y50	Cartes de Visite etc.
Standard Covers	76x112mm	3x4½"	75 Micron Polyester	25	C76112Y75Q	Cartes de Visite etc.
Standard Covers	76x112mm	3x4½"	75 Micron Polyester	50	C76112Y75	Cartes de Visite etc.
Standard Covers	76x152mm	3x6"	50 Micron Polyester	25	C76152Y50Q	3x6" prints, pictures, etc.
Standard Covers	76x152mm	3x6"	50 Micron Polyester	50	C76152Y50	3x6" prints, pictures, etc.
Standard Covers	76x152mm	3x6"	75 Micron Polyester	25	C176152Y75Q	3x6" prints, pictures, etc.
Standard Covers	76x152mm	3x6"	75 Micron Polyester	50	C176152Y75	3x6" prints, pictures, etc.
Standard Covers	108x134mm	5x4"	50 Micron Polyester	25	C108134Y50Q	5x4" prints, pictures, etc.
Standard Covers	108x134mm	5x4"	50 Micron Polyester	50	C10134Y50	5x4" prints, pictures, etc.
Standard Covers	108x134mm	5x4"	75 Micron Polyester	25	C108134Y75Q	5x4" prints, pictures, etc.
Standard Covers	108x134mm	5x4"	75 Micron Polyester	50	C108134Y75	5x4" prints, pictures, etc.
Standard Covers	115x155mm	A6	50 Micron Polyester	25	CA6Y50Q	4½x6" prints, etc.
Standard Covers	115x155mm	A6	50 Micron Polyester	50	CA6Y50	4½x6" prints, etc.
Standard Covers	115x155mm	A6	75 Micron Polyester	25	CA6Y75Q	4½x6" prints, etc.
Standard Covers	115x155mm	A6	75 Micron Polyester	50	CA6Y75	4½x6" prints, etc.
Standard Covers	127x127mm	CD	50 Micron Polyester	25	C 127127Y50Q	CD, DVD
Standard Covers	127x127mm	CD	50 Micron Polyester	50	C 127127Y50	CD, DVD
Standard Covers	127x127mm	CD	75 Micron Polyester	25	C 127127Y75Q	CD, DVD
Standard Covers	127x127mm	CD	75 Micron Polyester	50	C 127127Y75	CD, DVD
Standard Covers	127x127mm	CD	100 Micron Polyester	25	C127127Y100Q	CD, DVD
Standard Covers	127x127mm	CD	100 Micron Polyester	50	C127127Y100	CD, DVD
Standard Covers	134x184mm	5x7"	50 Micron Polyester	25	C134184Y50Q	5x7" prints, etc.
Standard Covers	134x184mm	5x7"	50 Micron Polyester	50	C134184Y50	5x7" prints, etc.
Standard Covers	134x184mm	5x7"	75 Micron Polyester	25	C134184Y75Q	5x7" prints, etc.
Standard Covers	134x184mm	5x7"	75 Micron Polyester	50	C134184Y75	5x7" prints, etc.
Standard Covers	134x184mm	5x7"	100 Micron Polyester	25	C134184Y100Q	5x7" prints, etc.
Standard Covers	134x184mm	5x7"	100 Micron Polyester	50	C134184Y100	5x7" prints, etc.
Standard Covers	152x203mm	Foolscap Quarto	50 Micron Polyester	25	C152203Y50Q	6½x8" prints, etc.
Standard Covers	152x203mm	Foolscap Quarto	50 Micron Polyester	50	C152203Y50	6½x8" prints, etc.
Standard Covers	152x203mm	Foolscap Quarto	75 Micron Polyester	25	C152203Y75Q	6½x8" prints, etc.
Standard Covers	152x203mm	Foolscap Quarto	75 Micron Polyester	50	C152203Y75	6½x8" prints, etc.
Standard Covers	152x203mm	Foolscap Quarto	100 Micron Polyester	25	C152203Y100Q	6½x8" prints, etc.
Standard Covers	152x203mm	Foolscap Quarto	100 Micron Polyester	50	C152203Y100	6½x8" prints, etc.
Standard Covers	152x230mm	6x9"	50 Micron Polyester	25	C152230Y50Q	6x9" prints, etc.
Standard Covers	152x230mm	6x9"	50 Micron Polyester	50	C152230Y50	6x9" prints, etc.
Standard Covers	152x230mm	6x9"	75 Micron Polyester	25	C152230Y75Q	6x9" prints, etc.
Standard Covers	152x230mm	6x9"	75 Micron Polyester	50	C152230Y75	6x9" prints, etc.
Standard Covers	152x230mm	6x9"	100 Micron Polyester	25	C152230Y100Q	6x9" prints, etc.
Standard Covers	152x230mm	6x9"	100 Micron Polyester	50	C152230Y100	6x9" prints, etc.

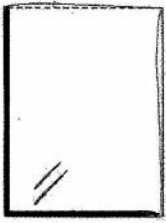

NAME	DIMENSIONS	FORMAT	CATEGORY	PACK OF	REF. NO	APPLICATION
Standard Covers	160x215mm	A5	50 Micron Polyester	25	CA5Y50Q	5.8x8.3" prints, documents, etc.
Standard Covers	160x215mm	A5	50 Micron Polyester	50	CA5Y50	5.8x8.3" prints, documents, etc.
Standard Covers	160x215mm	A5	75 Micron Polyester	25	CA5Y75Q	5.8x8.3" prints, documents, etc.
Standard Covers	160x215mm	A5	75 Micron Polyester	50	CA5Y75	5.8x8.3" prints, documents, etc.
Standard Covers	160x215mm	A5	100 Micron Polyester	25	CA5Y100Q	5.8x8.3" prints, documents etc.
Standard Covers	160x215mm	A5	100 Micron Polyester	50	CA5Y100	5.8x8.3" prints, documents, etc.
Standard Covers	203x330mm	Foolscap Folio	50 Micron Polyester	25	C203330Y50Q	8.5 x 13.5" prints, documents, etc.
Standard Covers	203x330mm	Foolscap Folio	50 Micron Polyester	50	C203330Y50	8.5 x 13.5" prints, documents, etc.
Standard Covers	203x330mm	Foolscap Folio	75 Micron Polyester	25	C203330Y75Q	8.5 x 13.5" prints, documents, etc.
Standard Covers	203x330mm	Foolscap Folio	75 Micron Polyester	50	C203330Y75	8.5 x 13.5" prints, documents, etc.
Standard Covers	203x330mm	Foolscap Folio	100 Micron Polyester	25	C203330Y100Q	8.5 x 13.5" prints, documents, etc.
Standard Covers	203x330mm	Foolscap Folio	100 Micron Polyester	50	C203330Y100	8.5 x 13.5" prints, documents, etc.
Standard Covers	210x258mm	8x10"	50 Micron Polyester	25	C210254Y50Q	8x10" prints, pictures, etc.
Standard Covers	210x258mm	8x10"	50 Micron Polyester	50	C210254Y50	8x10" prints, pictures, etc.
Standard Covers	210x258mm	8x10"	75 Micron Polyester	25	C210254Y75Q	8x10" prints, pictures, etc.
Standard Covers	210x258mm	8x10"	75 Micron Polyester	50	C210254Y75	8x10" prints, pictures, etc.
Standard Covers	210x258mm	8x10"	100 Micron Polyester	25	C210254Y100Q	8x10" prints, pictures, etc.
Standard Covers	210x258mm	8x10"	100 Micron Polyester	50	C210254Y100	8x10" prints, pictures, etc.
Standard Covers	220x305mm	A4	50 Micron Polyester	25	CA4Y50Q	8.3x11.7" prints, documents, etc.
Standard Covers	220x305mm	A4	50 Micron Polyester	50	CA4Y50	8.3x11.7" prints, documents, etc.
Standard Covers	220x305mm	A4	75 Micron Polyester	25	CA4Y75Q	8.3x11.7" prints, documents, etc.
Standard Covers	220x305mm	A4	75 Micron Polyester	50	CA4Y75	8.3x11.7" prints, documents, etc.
Standard Covers	220x305mm	A4	100 Micron Polyester	25	CA4Y100Q	8.3x11.7" prints, documents, etc.
Standard Covers	220x305mm	A4	100 Micron Polyester	50	CA4Y100	8.3x11.7" prints, documents, etc.
Standard Covers	230x305mm	9x12"	50 Micron Polyester	25	C230305Y50Q	9x12" prints, documents, etc.
Standard Covers	230x305mm	9x12"	50 Micron Polyester	50	C230305Y50	9x12" prints, documents, etc.
Standard Covers	230x305mm	9x12"	75 Micron Polyester	25	C230305Y75Q	9x12" prints, documents, etc.
Standard Covers	230x305mm	9x12"	75 Micron Polyester	50	C230305Y75	9x12" prints, documents, etc.
Standard Covers	230x305mm	9x12"	100 Micron Polyester	25	C230305Y100Q	9x12" prints, documents, etc.
Standard Covers	230x305mm	9x12"	100 Micron Polyester	50	C230305Y100	9x12" prints, documents, etc.
Standard Covers	260x305mm	10x12"	50 Micron Polyester	25	C260305Y50Q	12x10" prints, documents, etc.
Standard Covers	260x305mm	10x12"	50 Micron Polyester	50	C260305Y50	12x10" prints, documents, etc.
Standard Covers	260x305mm	10x12"	75 Micron Polyester	25	C260305Y75Q	12x10" prints, documents, etc.
Standard Covers	260x305mm	10x12"	75 Micron Polyester	50	C260305Y75	12x10" prints, documents, etc.
Standard Covers	260x305mm	10x12"	100 Micron Polyester	25	C260305Y100Q	12x10" prints, documents, etc.
Standard Covers	260x305mm	10x12"	100 Micron Polyester	50	C260305Y100	12x10" prints, documents, etc.
Standard Covers	267x381mm	Quarter Imperial	75 Micron Polyester	25	C267381Y75Q	Quarter Imperial prints, etc.
Standard Covers	267x381mm	Quarter Imperial	75 Micron Polyester	50	C267381Y75	Quarter Imperial prints, etc.
Standard Covers	267x381mm	Quarter Imperial	100 Micron Polyester	25	C267381Y100Q	Quarter Imperial prints, etc.
Standard Covers	267x381mm	Quarter Imperial	100 Micron Polyester	50	C267381Y100	Quarter Imperial prints, etc.
Standard Covers	305x381mm	12x15"	75 Micron Polyester	25	C305381Y75Q	12x 15" prints, etc.
Standard Covers	305x381mm	12x15"	75 Micron Polyester	50	C305381Y75	12x 15" prints, etc.
Standard Covers	305x381mm	12x15"	100 Micron Polyester	25	C305381Y100Q	12x 15" prints, etc.
Standard Covers	305x381mm	12x15"	100 Micron Polyester	50	C305381Y100	12x 15" prints, etc.



NAME	DIMENSIONS	FORMAT	CATEGORY	PACK OF	REF. NO	APPLICATION
Standard Covers	310x425mm	A3	75 Micron Polyester	25	CA3Y75Q	12 1/8"x 16 5/8" prints, pictures, etc.
Standard Covers	310x425mm	A3	75 Micron Polyester	50	CA3Y75	12 1/8"x 16 5/8" prints, pictures, etc.
Standard Covers	310x425mm	A3	100 Micron Polyester	25	CA3Y100Q	12 1/8"x 16 5/8" prints, pictures, etc.
Standard Covers	310x425mm	A3	100 Micron Polyester	50	CA3Y100	12 1/8"x 16 5/8" prints, pictures, etc.
Standard Covers	335x488mm	A3+	75 Micron Polyester	25	C335488Y75Q	13 1/4"x 19 1/4" prints, pictures, etc.
Standard Covers	335x488mm	A3+	75 Micron Polyester	50	C335488Y75	13 1/4"x 19 1/4" prints, pictures, etc.
Standard Covers	335x488mm	A3+	100 Micron Polyester	25	C335488Y100Q	13 1/4"x 19 1/4" prints, pictures, etc.
Standard Covers	335x488mm	A3+	100 Micron Polyester	50	C335488Y100	13 1/4"x 19 1/4" prints, pictures, etc.
Standard Covers	386x531mm	Half Imperial	75 Micron Polyester	25	C386531Y75Q	15x22" prints, pictures, etc.
Standard Covers	386x531mm	Half Imperial	75 Micron Polyester	50	C386531Y75	15x22" prints, pictures, etc.
Standard Covers	386x531mm	Half Imperial	100 Micron Polyester	25	C386531Y100Q	15x22" prints, pictures, etc.
Standard Covers	386x531mm	Half Imperial	100 Micron Polyester	50	C386531Y100	15x22" prints, pictures, etc.
Standard Covers	412x508mm	16 1/4x 20"	75 Micron Polyester	25	C412508Y75Q	16x20" prints, pictures, etc.
Standard Covers	412x508mm	16 1/4x 20"	75 Micron Polyester	50	C412508Y75	16x20" prints, pictures, etc.
Standard Covers	412x508mm	16 1/4x 20"	100 Micron Polyester	25	C412508Y100Q	16x20" prints, pictures, etc.
Standard Covers	412x508mm	16 1/4x 20"	100 Micron Polyester	50	C412508Y100	16x20" prints, pictures, etc.
Standard Covers	430x600mm	A2	75 Micron Polyester	25	CA2Y75Q	16 7/8x 23 1/2" prints, pictures, etc.
Standard Covers	430x600mm	A2	75 Micron Polyester	50	CA2Y75	16 7/8x 23 1/2" prints, pictures, etc.
Standard Covers	430x600mm	A2	100 Micron Polyester	25	CA2Y100Q	16 7/8x 23 1/2" prints, pictures, etc.
Standard Covers	430x600mm	A2	100 Micron Polyester	50	CA2Y100	16 7/8x 23 1/2" prints, pictures, etc.
Standard Covers	521x725mm	20 1/2x 28 1/2"	75 Micron Polyester	25	C521725Y75Q	20 1/2x 28 1/2" prints, pictures, etc.
Standard Covers	521x725mm	20 1/2x 28 1/2"	75 Micron Polyester	50	C521725Y75	20 1/2x 28 1/2" prints, pictures, etc.
Standard Covers	521x725mm	20 1/2x 28 1/2"	100 Micron Polyester	25	C521725Y100Q	20 1/2x 28 1/2" prints, pictures, etc.
Standard Covers	521x725mm	20 1/2x 28 1/2"	100 Micron Polyester	50	C521725Y100	20 1/2x 28 1/2" prints, pictures, etc.
Standard Covers	605x845mm	A1	75 Micron Polyester	25	CA1Y75Q	23 3/4x 33 1/4" prints, pictures, etc.
Standard Covers	605x845mm	A1	75 Micron Polyester	50	CA1Y75	23 3/4x 33 1/4" prints, pictures, etc.
Standard Covers	605x845mm	A1	100 Micron Polyester	25	CA1Y100Q	23 3/4x 33 1/4" prints, pictures, etc.
Standard Covers	605x845mm	A1	100 Micron Polyester	50	CA1Y100	23 3/4x 33 1/4" prints, pictures, etc.
Standard Covers	775x1025mm	Standard OS. map	100 Micron Polyester	10	C7751025Y100	30 1/2x 40 1/4" Standard O.S. map
Standard Covers	857x1207mm	A0	100 Micron Polyester	10	C8571207Y100	33 3/4"x 47 1/2" A0 Maps, posters etc.

## 4 STANDARD POLYESTER FOLDERS

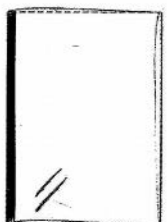

The Secol Standard Polyester Folders are completely inert and acid-free. They are welded on 1 long side and open on the other three for a simple or temporary enclosure. They are not punched. Many other formats are available as bespoke service.

*For Folders with clip-lock fold on opposite side turn to Trantec® Sleeves on page 28.*

NAME	DIMENSIONS	FORMAT	CATEGORY	PACK OF	REF. NO	APPLICATION
Standard Folders	76x112mm	3x4 1/2"	50 Micron Polyester	25	F76112Y50Q	Cartes de Visite etc.
Standard Folders	76x112mm	3x4 1/2"	50 Micron Polyester	50	F76112Y50	Cartes de Visite etc.
Standard Folders	76x112mm	3x4 1/2"	75 Micron Polyester	25	F76112Y75Q	Cartes de Visite etc.
Standard Folders	76x112mm	3x4 1/2"	75 Micron Polyester	50	F76112Y75	Cartes de Visite etc.



NAME	DIMENSIONS	FORMAT	CATEGORY	PACK OF	REF. NO	APPLICATION
Standard Folders	76x152mm	3x6"	50 Micron Polyester	25	F76152Y50Q	3x6" prints, pictures, etc.
Standard Folders	76x152mm	3x6"	50 Micron Polyester	50	F76152Y50	3x6" prints, pictures, etc.
Standard Folders	76x152mm	3x6"	75 Micron Polyester	25	F176152Y75Q	3x6" prints, pictures, etc.
Standard Folders	76x152mm	3x6"	75 Micron Polyester	50	F176152Y75	3x6" prints, pictures, etc.
Standard Folders	108x134mm	5x4"	50 Micron Polyester	25	F108134Y50Q	5x4" prints, pictures, etc.
Standard Folders	108x134mm	5x4"	50 Micron Polyester	50	F108134Y50	5x4" prints, pictures, etc.
Standard Folders	108x134mm	5x4"	75 Micron Polyester	25	F108134Y75Q	5x4" prints, pictures, etc.
Standard Folders	108x134mm	5x4"	75 Micron Polyester	50	F108134Y75	5x4" prints, pictures, etc.
Standard Folders	115x155mm	A6	50 Micron Polyester	25	FA6Y50Q	4.5x6" prints, pictures, etc.
Standard Folders	115x155mm	A6	50 Micron Polyester	50	FA6Y50	4.5x6" prints, pictures, etc.
Standard Folders	115x155mm	A6	75 Micron Polyester	25	FA6Y75Q	4.5x6" prints, pictures, etc.
Standard Folders	115x155mm	A6	75 Micron Polyester	50	FA6Y75	4.5x6" prints, pictures, etc.
Standard Folders	127x127mm	CD	50 Micron Polyester	25	F127127Y50Q	CD, DVD
Standard Folders	127x127mm	CD	50 Micron Polyester	50	F127127Y50	CD, DVD
Standard Folders	127x127mm	CD	75 Micron Polyester	25	F127127Y75Q	CD, DVD
Standard Folders	127x127mm	CD	75 Micron Polyester	50	F127127Y75	CD, DVD
Standard Folders	127x127mm	CD	100 Micron Polyester	25	F127127Y100Q	CD, DVD
Standard Folders	127x127mm	CD	100 Micron Polyester	50	F127127Y100	CD, DVD
Standard Folders	134x184mm	5x7"	50 Micron Polyester	25	F134184Y50Q	5x7" prints, pictures, etc.
Standard Folders	134x184mm	5x7"	50 Micron Polyester	50	F134184Y50	5x7" prints, pictures, etc.
Standard Folders	134x184mm	5x7"	75 Micron Polyester	25	F134184Y75Q	5x7" prints, pictures, etc.
Standard Folders	134x184mm	5x7"	75 Micron Polyester	50	F134184Y75	5x7" prints, pictures, etc.
Standard Folders	134x184mm	5x7"	100 Micron Polyester	25	F134184Y100Q	5x7" prints, pictures, etc.
Standard Folders	134x184mm	5x7"	100 Micron Polyester	50	F134184Y100	5x7" prints, pictures, etc.
Standard Folders	152x203mm	Foolscap Quarto	50 Micron Polyester	25	F152203Y50Q	6.5x8" prints, pictures, etc.
Standard Folders	152x203mm	Foolscap Quarto	50 Micron Polyester	50	F152203Y50	6.5x8" prints, pictures, etc.
Standard Folders	152x203mm	Foolscap Quarto	75 Micron Polyester	25	F152203Y75Q	6.5x8" prints, pictures, etc.
Standard Folders	152x203mm	Foolscap Quarto	75 Micron Polyester	50	F152203Y75	6.5x8" prints, pictures, etc.
Standard Folders	152x203mm	Foolscap Quarto	100 Micron Polyester	25	F152203Y100Q	6.5x8" prints, pictures, etc.
Standard Folders	152x203mm	Foolscap Quarto	100 Micron Polyester	50	F152203Y100	6.5x8" prints, pictures, etc.
Standard Folders	152x230mm	6x9"	50 Micron Polyester	25	F152230Y50Q	6x9" prints, pictures, etc.
Standard Folders	152x230mm	6x9"	50 Micron Polyester	50	F152230Y50	6x9" prints, pictures, etc.
Standard Folders	152x230mm	6x9"	75 Micron Polyester	25	F152230Y75Q	6x9" prints, pictures, etc.
Standard Folders	152x230mm	6x9"	75 Micron Polyester	50	F152230Y75	6x9" prints, pictures, etc.
Standard Folders	152x230mm	6x9"	100 Micron Polyester	25	F152230Y100Q	6x9" prints, pictures, etc.
Standard Folders	152x230mm	6x9"	100 Micron Polyester	50	F152230Y100	6x9" prints, pictures, etc.
Standard Folders	160x215mm	A5	50 Micron Polyester	25	FA5Y50Q	5.8x8.3" prints, pictures, etc.
Standard Folders	160x215mm	A5	50 Micron Polyester	50	FA5Y50	5.8x8.3" prints, pictures, etc.
Standard Folders	160x215mm	A5	75 Micron Polyester	25	FA5Y75Q	5.8x8.3" prints, pictures, etc.
Standard Folders	160x215mm	A5	75 Micron Polyester	50	FA5Y75	5.8x8.3" prints, pictures, etc.
Standard Folders	160x215mm	A5	100 Micron Polyester	25	FA5Y100Q	5.8x8.3" prints, pictures, etc.
Standard Folders	160x215mm	A5	100 Micron Polyester	50	FA5Y100	5.8x8.3" prints, pictures, etc.

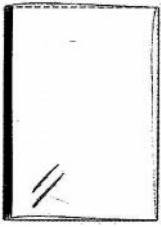

NAME	DIMENSIONS	FORMAT	CATEGORY	PACK OF	REF. NO	APPLICATION
Standard Folders	203x330mm	Foolscap Folio	50 Micron Polyester	25	F203330Y50Q	8.5 x 13.5" prints, pictures, etc.
Standard Folders	203x330mm	Foolscap Folio	50 Micron Polyester	50	F203330Y50	8.5 x 13.5" prints, pictures, etc.
Standard Folders	203x330mm	Foolscap Folio	75 Micron Polyester	25	F203330Y75Q	8.5 x 13.5" prints, pictures, etc.
Standard Folders	203x330mm	Foolscap Folio	75 Micron Polyester	50	F203330Y75	8.5 x 13.5" prints, pictures, etc.
Standard Folders	203x330mm	Foolscap Folio	100 Micron Polyester	25	F203330Y100Q	8.5 x 13.5" prints, pictures, etc.
Standard Folders	203x330mm	Foolscap Folio	100 Micron Polyester	50	F203330Y100	8.5 x 13.5" prints, pictures, etc.
Standard Folders	210x258mm	8x10"	50 Micron Polyester	25	F210254Y50Q	8x10" prints, pictures, etc.
Standard Folders	210x258mm	8x10"	50 Micron Polyester	50	F210254Y50	8x10" prints, pictures, etc.
Standard Folders	210x258mm	8x10"	75 Micron Polyester	25	F210254Y75Q	8x10" prints, pictures, etc.
Standard Folders	210x258mm	8x10"	75 Micron Polyester	50	F210254Y75	8x10" prints, pictures, etc.
Standard Folders	210x258mm	8x10"	100 Micron Polyester	25	F210254Y100Q	8x10" prints, pictures, etc.
Standard Folders	210x258mm	8x10"	100 Micron Polyester	50	F210254Y100	8x10" prints, pictures, etc.
Standard Folders	220x305mm	A4	50 Micron Polyester	25	FA4Y50Q	8.3x11.7" prints, documents, etc.
Standard Folders	220x305mm	A4	50 Micron Polyester	50	FA4Y50	8.3x11.7" prints, documents, etc.
Standard Folders	220x305mm	A4	75 Micron Polyester	25	FA4Y75Q	8.3x11.7" prints, documents, etc.
Standard Folders	220x305mm	A4	75 Micron Polyester	50	FA4Y75	8.3x11.7" prints, documents, etc.
Standard Folders	220x305mm	A4	100 Micron Polyester	25	FA4Y100Q	8.3x11.7" prints, documents, etc.
Standard Folders	220x305mm	A4	100 Micron Polyester	50	FA4Y100	8.3x11.7" prints, documents, etc.
Standard Folders	230x305mm	9x12"	50 Micron Polyester	25	F230305Y50Q	9x12" prints, documents, etc.
Standard Folders	230x305mm	9x12"	50 Micron Polyester	50	F230305Y50	9x12" prints, documents, etc.
Standard Folders	230x305mm	9x12"	75 Micron Polyester	25	F230305Y75Q	9x12" prints, documents, etc.
Standard Folders	230x305mm	9x12"	75 Micron Polyester	50	F230305Y75	9x12" prints, documents, etc.
Standard Folders	230x305mm	9x12"	100 Micron Polyester	25	F230305Y100Q	9x12" prints, documents, etc.
Standard Folders	230x305mm	9x12"	100 Micron Polyester	50	F230305Y100	9x12" prints, documents, etc.
Standard Folders	260x305mm	10x12"	50 Micron Polyester	25	F260305Y50Q	12x10" prints, documents, etc.
Standard Folders	260x305mm	10x12"	50 Micron Polyester	50	F260305Y50	12x10" prints, documents, etc.
Standard Folders	260x305mm	10x12"	75 Micron Polyester	25	F260305Y75Q	12x10" prints, documents, etc.
Standard Folders	260x305mm	10x12"	75 Micron Polyester	50	F260305Y75	12x10" prints, documents, etc.
Standard Folders	260x305mm	10x12"	100 Micron Polyester	25	F260305Y100Q	12x10" prints, documents, etc.
Standard Folders	260x305mm	10x12"	100 Micron Polyester	50	F260305Y100	12x10" prints, documents, etc.
Standard Folders	267x381mm	Quarter Imperial	75 Micron Polyester	25	F267381Y75Q	Quarter Imperial prints, etc.
Standard Folders	267x381mm	Quarter Imperial	75 Micron Polyester	50	F267381Y75	Quarter Imperial prints, etc.
Standard Folders	267x381mm	Quarter Imperial	100 Micron Polyester	25	F267381Y100Q	Quarter Imperial prints, etc.
Standard Folders	267x381mm	Quarter Imperial	100 Micron Polyester	50	F267381Y100	Quarter Imperial prints, etc.
Standard Folders	305x381mm	12x15"	75 Micron Polyester	25	F305381Y75Q	12x 15" prints, etc.
Standard Folders	305x381mm	12x15"	75 Micron Polyester	50	F305381Y75	12x 15" prints, etc.
Standard Folders	305x381mm	12x15"	100 Micron Polyester	25	F05381Y100Q	12x 15" prints, etc.
Standard Folders	305x381mm	12x15"	100 Micron Polyester	50	F305381Y100	12x 15" prints, etc.

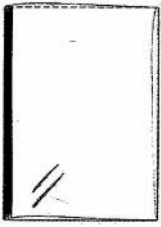

NAME	DIMENSIONS	FORMAT	CATEGORY	PACK OF	REF. NO	APPLICATION
Standard Folders	310x425mm	A3	75 Micron Polyester	25	FA3Y75Q	12 1/8"x 16 5/8" prints, documents, etc.
Standard Folders	310x425mm	A3	75 Micron Polyester	50	FA3Y75	12 1/8"x 16 5/8" prints, documents, etc.
Standard Folders	310x425mm	A3	100 Micron Polyester	25	FA3Y100Q	12 1/8"x 16 5/8" prints, documents, etc.
Standard Folders	310x425mm	A3	100 Micron Polyester	50	FA3Y100	12 1/8"x 16 5/8" prints, documents, etc.
Standard Folders	335x488mm	A3+	75 Micron Polyester	25	F335488Y75Q	13 1/4"x 19 1/4" prints, documents, etc.
Standard Folders	335x488mm	A3+	75 Micron Polyester	50	F335488Y75	13 1/4"x 19 1/4" prints, documents, etc.
Standard Folders	335x488mm	A3+	100 Micron Polyester	25	F335488Y100Q	13 1/4"x 19 1/4" prints, documents, etc.
Standard Folders	335x488mm	A3+	100 Micron Polyester	50	F335488Y100	13 1/4"x 19 1/4" prints, documents, etc.
Standard Folders	386x531mm	Half Imperial	75 Micron Polyester	25	F386531Y75Q	15x22" prints, pictures, etc.
Standard Folders	386x531mm	Half Imperial	75 Micron Polyester	50	F386531Y75	15x22" prints, pictures, etc.
Standard Folders	386x531mm	Half Imperial	100 Micron Polyester	25	F386531Y100Q	15x22" prints, pictures, etc.
Standard Folders	386x531mm	Half Imperial	100 Micron Polyester	50	F386531Y100	15x22" prints, pictures, etc.
Standard Folders	412x508mm	16 1/4x 20"	75 Micron Polyester	25	F412508Y75Q	16x20" prints, pictures, etc.
Standard Folders	412x508mm	16 1/4x 20"	75 Micron Polyester	50	F412508Y75	16x20" prints, pictures, etc.
Standard Folders	412x508mm	16 1/4x 20"	100 Micron Polyester	25	F412508Y100Q	16x20" prints, pictures, etc.
Standard Folders	412x508mm	16 1/4x 20"	100 Micron Polyester	50	F412508Y100	16x20" prints, pictures, etc.
Standard Folders	430x600mm	A2	75 Micron Polyester	25	FA2Y75Q	16 7/8x 23 1/2" prints, pictures, etc.
Standard Folders	430x600mm	A2	75 Micron Polyester	50	FA2Y75	16 7/8x 23 1/2" prints, pictures, etc.
Standard Folders	430x600mm	A2	100 Micron Polyester	25	FA2Y100Q	16 7/8x 23 1/2" prints, pictures, etc.
Standard Folders	430x600mm	A2	100 Micron Polyester	50	FA2Y100	16 7/8x 23 1/2" prints, pictures, etc.
Standard Folders	521x725mm	20 1/2x 28 1/2"	75 Micron Polyester	25	F521725Y75Q	20 1/2x 28 1/2" prints, pictures, etc.
Standard Folders	521x725mm	20 1/2x 28 1/2"	75 Micron Polyester	50	F521725Y75	20 1/2x 28 1/2" prints, pictures, etc.
Standard Folders	521x725mm	20 1/2x 28 1/2"	100 Micron Polyester	25	F521725Y100Q	20 1/2x 28 1/2" prints, pictures, etc.
Standard Folders	521x725mm	20 1/2x 28 1/2"	100 Micron Polyester	50	F521725Y100	20 1/2x 28 1/2" prints, pictures, etc.
Standard Folders	605x845mm	A1	75 Micron Polyester	25	FA1Y75Q	23 3/4x 33 1/4" prints, pictures, etc.
Standard Folders	605x845mm	A1	75 Micron Polyester	50	FA1Y75	23 3/4x 33 1/4" prints, pictures, etc.
Standard Folders	605x845mm	A1	100 Micron Polyester	25	FA1Y100Q	23 3/4x 33 1/4" prints, pictures, etc.
Standard Folders	605x845mm	A1	100 Micron Polyester	50	FA1Y100	23 3/4x 33 1/4" prints, pictures, etc.
Standard Folders	775x1025mm	Standard OS. map	100 Micron Polyester	10	F7751025Y100	30 1/2x 40 1/4" Standard O.S. map
Standard Folders	857x1207mm	A0	100 Micron Polyester	10	F8571207Y100	33 3/4"x 47 1/2" A0 Maps, posters etc.

## V Polyester Sleeves & Sleeve Rolls

The Secol Polyester Sleeves are manufactured from glass-clear Polyester film that provides superb quality and reliability.

Sleeves are open on two short sides and welded on the 2 long sides. They are not punched. Trantec® Sleeves are welded on one long side and opens up completely for simple and safe insertion. The sleeves are then closed and a neat welded "captive flap" locks over the opposing edge to retain the contents safely inside.

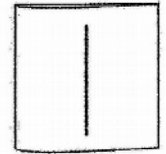
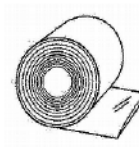
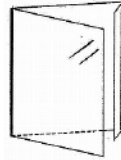
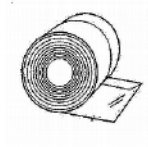

The Transleeves, Standard and Trantec® Sleeves offer wide range of formats, sizes and styles to meet varying requirements.

The archival grade Polyester is also available in a wide variety of unwelded formats. The Standard Rolls are available in 75 Micron Polyester but Secol are able to offer Polyester material in exactly the right sizes and other thicknesses as bespoke service.

### 1 Standard Polyester Sleeves

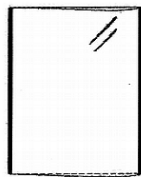

NAME	DIMENSIONS	FORMAT	CATEGORY	PACK OF	REF NO	APPLICATION
Standard Sleeves	76x112mm	3x4½"	50 Micron Polyester	25	S76112Y50Q	Cartes de Visite etc.
Standard Sleeves	76x112mm	3x4½"	50 Micron Polyester	50	S76112Y50	Cartes de Visite etc.
Standard Sleeves	76x112mm	3x4½"	75 Micron Polyester	25	S76112Y75Q	Cartes de Visite etc.
Standard Sleeves	76x112mm	3x4½"	75 Micron Polyester	50	S76112Y75	Cartes de Visite etc.
Standard Sleeves	76x152mm	3x6"	50 Micron Polyester	25	S76152Y50Q	3x6" prints, pictures, etc.
Standard Sleeves	76x152mm	3x6"	50 Micron Polyester	50	S76152Y50	3x6" prints, pictures, etc.
Standard Sleeves	76x152mm	3x6"	75 Micron Polyester	25	S176152Y75Q	3x6" prints, pictures, etc.
Standard Sleeves	76x152mm	3x6"	75 Micron Polyester	50	S176152Y75	3x6" prints, pictures, etc.
Standard Sleeves	108x134mm	5x4"	50 Micron Polyester	25	S108134Y50Q	5x4" prints, pictures, etc.
Standard Sleeves	108x134mm	5x4"	50 Micron Polyester	50	S108134Y50	5x4" prints, pictures, etc.
Standard Sleeves	108x134mm	5x4"	75 Micron Polyester	25	S108134Y75Q	5x4" prints, pictures, etc.
Standard Sleeves	108x134mm	5x4"	75 Micron Polyester	50	S108134Y75	5x4" prints, pictures, etc.
Standard Sleeves	115x155mm	A6	50 Micron Polyester	25	SA6Y50Q	4.5x6" prints, pictures, etc.
Standard Sleeves	115x155mm	A6	50 Micron Polyester	50	SA6Y50	4.5x6" prints, pictures, etc.
Standard Sleeves	115x155mm	A6	75 Micron Polyester	25	SA6Y75Q	4.5x6" prints, pictures, etc.
Standard Sleeves	115x155mm	A6	75 Micron Polyester	50	SA6Y75	4.5x6" prints, pictures, etc.
Standard Sleeves	127x127mm	CD	50 Micron Polyester	25	S127127Y50Q	CD, DVD
Standard Sleeves	127x127mm	CD	50 Micron Polyester	50	S127127Y50	CD, DVD
Standard Sleeves	127x127mm	CD	75 Micron Polyester	25	S127127Y75Q	CD, DVD
Standard Sleeves	127x127mm	CD	75 Micron Polyester	50	S127127Y75	CD, DVD
Standard Sleeves	127x127mm	CD	100 Micron Polyester	25	S127127Y100Q	CD, DVD
Standard Sleeves	127x127mm	CD	100 Micron Polyester	50	S127127Y100	CD, DVD
Standard Sleeves	134x184mm	5x7"	50 Micron Polyester	25	S134184Y50Q	5x7" prints, pictures, etc.
Standard Sleeves	134x184mm	5x7"	50 Micron Polyester	50	S134184Y50	5x7" prints, pictures, etc.
Standard Sleeves	134x184mm	5x7"	75 Micron Polyester	25	S134184Y75Q	5x7" prints, pictures, etc.
Standard Sleeves	134x184mm	5x7"	75 Micron Polyester	50	S134184Y75	5x7" prints, pictures, etc.
Standard Sleeves	134x184mm	5x7"	100 Micron Polyester	25	S134184Y100Q	5x7" prints, pictures, etc.
Standard Sleeves	134x184mm	5x7"	100 Micron Polyester	50	S134184Y100	5x7" prints, pictures, etc.

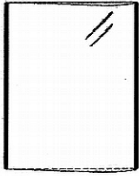

NAME	DIMENSIONS	FORMAT	CATEGORY	PACK OF	REF NO	APPLICATION
Standard Sleeves	152x203mm	Foolscap Quarto	50 Micron Polyester	25	S152203Y50Q	6.5x8" prints, pictures, etc.
Standard Sleeves	152x203mm	Foolscap Quarto	50 Micron Polyester	50	S152203Y50	6.5x8" prints, pictures, etc.
Standard Sleeves	152x203mm	Foolscap Quarto	75 Micron Polyester	25	S152203Y75Q	6.5x8" prints, pictures, etc.
Standard Sleeves	152x203mm	Foolscap Quarto	75 Micron Polyester	50	S152203Y75	6.5x8" prints, documents, etc.
Standard Sleeves	152x203mm	Foolscap Quarto	100 Micron Polyester	25	S152203Y100Q	6.5x8" prints, documents, etc.
Standard Sleeves	152x203mm	Foolscap Quarto	100 Micron Polyester	50	S152203Y100	6.5x8" prints, documents, etc.
Standard Sleeves	152x230mm	6x9"	50 Micron Polyester	25	S152230Y50Q	6x9" prints, documents, etc.
Standard Sleeves	152x230mm	6x9"	50 Micron Polyester	50	S152230Y50	6x9" prints, documents, etc.
Standard Sleeves	152x230mm	6x9"	75 Micron Polyester	25	S152230Y75Q	6x9" prints, documents, etc.
Standard Sleeves	152x230mm	6x9"	75 Micron Polyester	50	S152230Y75	6x9" prints, documents, etc.
Standard Sleeves	152x230mm	6x9"	100 Micron Polyester	25	S152230Y100Q	6x9" prints, documents, etc.
Standard Sleeves	152x230mm	6x9"	100 Micron Polyester	50	S152230Y100	6x9" prints, documents, etc.
Standard Sleeves	160x215mm	A5	50 Micron Polyester	25	SA5Y50Q	5.8x8.3" prints, documents, etc.
Standard Sleeves	160x215mm	A5	50 Micron Polyester	50	SA5Y50	5.8x8.3" prints, documents, etc.
Standard Sleeves	160x215mm	A5	75 Micron Polyester	25	SA5Y75Q	5.8x8.3" prints, documents, etc.
Standard Sleeves	160x215mm	A5	75 Micron Polyester	50	SA5Y75	5.8x8.3" prints, documents, etc.
Standard Sleeves	160x215mm	A5	100 Micron Polyester	25	SA5Y100Q	5.8x8.3" prints, documents, etc.
Standard Sleeves	160x215mm	A5	100 Micron Polyester	50	SA5Y100	5.8x8.3" prints, documents, etc.
Standard Sleeves	203x330mm	Foolscap Folio	50 Micron Polyester	25	S203330Y50Q	8.5 x 13.5" prints, documents, etc.
Standard Sleeves	203x330mm	Foolscap Folio	50 Micron Polyester	50	S203330Y50	8.5 x 13.5" prints, documents, etc.
Standard Sleeves	203x330mm	Foolscap Folio	75 Micron Polyester	25	S203330Y75Q	8.5 x 13.5" prints, documents, etc.
Standard Sleeves	203x330mm	Foolscap Folio	75 Micron Polyester	50	S203330Y75	8.5 x 13.5" prints, documents, etc.
Standard Sleeves	203x330mm	Foolscap Folio	100 Micron Polyester	25	S203330Y100Q	8.5 x 13.5" prints, documents, etc.
Standard Sleeves	203x330mm	Foolscap Folio	100 Micron Polyester	50	S203330Y100	8.5 x 13.5" prints, documents, etc.
Standard Sleeves	210x258mm	8x10"	50 Micron Polyester	25	S210254Y50Q	8x10" prints, documents, etc.
Standard Sleeves	210x258mm	8x10"	50 Micron Polyester	50	S210254Y50	8x10" prints, documents, etc.
Standard Sleeves	210x258mm	8x10"	75 Micron Polyester	25	S210254Y75Q	8x10" prints, documents, etc.
Standard Sleeves	210x258mm	8x10"	75 Micron Polyester	50	S210254Y75	8x10" prints, documents, etc.
Standard Sleeves	210x258mm	8x10"	100 Micron Polyester	25	S210254Y100Q	8x10" prints, documents, etc.
Standard Sleeves	210x258mm	8x10"	100 Micron Polyester	50	S210254Y100	8x10" prints, documents, etc.
Standard Sleeves	220x305mm	A4	50 Micron Polyester	25	SA4Y50Q	8.3x11.7" prints, documents, etc.
Standard Sleeves	220x305mm	A4	50 Micron Polyester	50	SA4Y50	8.3x11.7" prints, documents, etc.
Standard Sleeves	220x305mm	A4	75 Micron Polyester	25	SA4Y75Q	8.3x11.7" prints, documents, etc.
Standard Sleeves	220x305mm	A4	75 Micron Polyester	50	SA4Y75	8.3x11.7" prints, documents, etc.
Standard Sleeves	220x305mm	A4	100 Micron Polyester	25	SA4Y100Q	8.3x11.7" prints, documents, etc.
Standard Sleeves	220x305mm	A4	100 Micron Polyester	50	SA4Y100	8.3x11.7" prints, documents, etc.
Standard Sleeves	230x305mm	9x12"	50 Micron Polyester	25	S230305Y50Q	9x12" prints, documents, etc.
Standard Sleeves	230x305mm	9x12"	50 Micron Polyester	50	S230305Y50	9x12" prints, documents, etc.
Standard Sleeves	230x305mm	9x12"	75 Micron Polyester	25	S230305Y75Q	9x12" prints, documents, etc.
Standard Sleeves	230x305mm	9x12"	75 Micron Polyester	50	S230305Y75	9x12" prints, documents, etc.
Standard Sleeves	230x305mm	9x12"	100 Micron Polyester	25	S230305Y100Q	9x12" prints, documents, etc.
Standard Sleeves	230x305mm	9x12"	100 Micron Polyester	50	S230305Y100	9x12" prints, documents, etc.



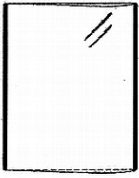

NAME	DIMENSIONS	FORMAT	CATEGORY	PACK OF	REF NO	APPLICATION
Standard Sleeves	260x305mm	10x12"	50 Micron Polyester	25	S260305Y50Q	12x10" prints, documents, etc.
Standard Sleeves	260x305mm	10x12"	50 Micron Polyester	50	S260305Y50	12x10" prints, documents, etc.
Standard Sleeves	260x305mm	10x12"	75 Micron Polyester	25	S260305Y75Q	12x10" prints, documents, etc.
Standard Sleeves	260x305mm	10x12"	75 Micron Polyester	50	S260305Y75	12x10" prints, documents, etc.
Standard Sleeves	260x305mm	10x12"	100 Micron Polyester	25	S260305Y100Q	12x10" prints, documents, etc.
Standard Sleeves	260x305mm	10x12"	100 Micron Polyester	50	S260305Y100	12x10" prints, documents, etc.
Standard Sleeves	267x381mm	Quarter Imperial	75 Micron Polyester	25	S267381Y75Q	Quarter Imperial prints, etc.
Standard Sleeves	267x381mm	Quarter Imperial	75 Micron Polyester	50	S267381Y75	Quarter Imperial prints, etc.
Standard Sleeves	267x381mm	Quarter Imperial	100 Micron Polyester	25	S267381Y100Q	Quarter Imperial prints, etc.
Standard Sleeves	267x381mm	Quarter Imperial	100 Micron Polyester	50	S267381Y100	Quarter Imperial prints, etc.
Standard Sleeves	305x381mm	12x15"	75 Micron Polyester	25	S305381Y75Q	12x 15" prints, etc.
Standard Sleeves	305x381mm	12x15"	75 Micron Polyester	50	S305381Y75	12x 15" prints, etc.
Standard Sleeves	305x381mm	12x15"	100 Micron Polyester	25	S05381Y100Q	12x 15" prints, etc.
Standard Sleeves	305x381mm	12x15"	100 Micron Polyester	50	S305381Y100	12x 15" prints, etc.
Standard Sleeves	310x425mm	A3	75 Micron Polyester	25	SA3Y75Q	12 1/8"x 16 5/8" prints, documents, etc.
Standard Sleeves	310x425mm	A3	75 Micron Polyester	50	SA3Y75	12 1/8"x 16 5/8" prints, documents, etc.
Standard Sleeves	310x425mm	A3	100 Micron Polyester	25	SA3Y100Q	12 1/8"x 16 5/8" prints, documents, etc.
Standard Sleeves	310x425mm	A3	100 Micron Polyester	50	SA3Y100	12 1/8"x 16 5/8" prints, documents, etc.
Standard Sleeves	335x488mm	A3+	75 Micron Polyester	25	S335488Y75Q	13 1/4"x 19 1/4" prints, documents, etc.
Standard Sleeves	335x488mm	A3+	75 Micron Polyester	50	S335488Y75	13 1/4"x 19 1/4" prints, documents, etc.
Standard Sleeves	335x488mm	A3+	100 Micron Polyester	25	S335488Y100Q	13 1/4"x 19 1/4" prints, documents, etc.
Standard Sleeves	335x488mm	A3+	100 Micron Polyester	50	S335488Y100	13 1/4"x 19 1/4" prints, documents, etc.
Standard Sleeves	386x531mm	Half Imperial	75 Micron Polyester	25	S386531Y75Q	15x22" prints, documents, etc.
Standard Sleeves	386x531mm	Half Imperial	75 Micron Polyester	50	S386531Y75	15x22" prints, documents, etc.
Standard Sleeves	386x531mm	Half Imperial	100 Micron Polyester	25	S386531Y100Q	15x22" prints, documents, etc.
Standard Sleeves	386x531mm	Half Imperial	100 Micron Polyester	50	S386531Y100	15x22" prints, documents, etc.
Standard Sleeves	412x508mm	16 1/4x 20"	75 Micron Polyester	25	S412508Y75Q	16x20" prints, documents, etc.
Standard Sleeves	412x508mm	16 1/4x 20"	75 Micron Polyester	50	S412508Y75	16x20" prints, documents, etc.
Standard Sleeves	412x508mm	16 1/4x 20"	100 Micron Polyester	25	S412508Y100Q	16x20" prints, documents, etc.
Standard Sleeves	412x508mm	16 1/4x 20"	100 Micron Polyester	50	S412508Y100	16x20" prints, documents, etc.
Standard Sleeves	430x600mm	A2	75 Micron Polyester	25	SA2Y75Q	16 7/8x 23 1/2" prints, documents, etc.
Standard Sleeves	430x600mm	A2	75 Micron Polyester	50	SA2Y75	16 7/8x 23 1/2" prints, documents, etc.
Standard Sleeves	430x600mm	A2	100 Micron Polyester	25	SA2Y100Q	16 7/8x 23 1/2" prints, documents, etc.
Standard Sleeves	430x600mm	A2	100 Micron Polyester	50	SA2Y100	16 7/8x 23 1/2" prints, documents, etc.



NAME	DIMENSIONS	FORMAT	CATEGORY	PACK OF	REF NO	APPLICATION
Standard Sleeves	521x725mm	20½x 28½"	75 Micron Polyester	25	S521725Y75Q	20½x 28½" prints, documents, etc.
Standard Sleeves	521x725mm	20½x 28½"	75 Micron Polyester	50	S521725Y75	20½x 28½" prints, documents, etc.
Standard Sleeves	521x725mm	20½x 28½"	100 Micron Polyester	25	S521725Y100Q	20½x 28½" prints, documents, etc.
Standard Sleeves	521x725mm	20½x 28½"	100 Micron Polyester	50	S521725Y100	20½x 28½" prints, documents, etc.
Standard Sleeves	605x845mm	A1	75 Micron Polyester	25	SA1Y75Q	23¾x 33¼" prints, documents, etc.
Standard Sleeves	605x845mm	A1	75 Micron Polyester	50	SA1Y75	23¾x 33¼" prints, documents, etc.
Standard Sleeves	605x845mm	A1	100 Micron Polyester	25	SA1Y100Q	23¾x 33¼" prints, documents, etc.
Standard Sleeves	605x845mm	A1	100 Micron Polyester	50	SA1Y100	23¾x 33¼" prints, documents, etc.
Standard Sleeves	775x1025mm	Standard O.S. map	100 Micron Polyester	10	S7751025Y100	30½x 40¼" Standard O.S. map
Standard Sleeves	857x1207mm	A0	100 Micron Polyester	10	S8571207Y100	33¾"x 47½" A0 Maps, posters etc.

## 2 Postcard Sleeves

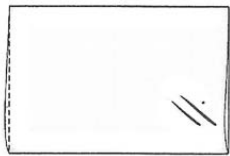

Postcards offer fascinating insights into social history and many have become extremely valuable. The use of PVC postcard pockets damage both the view and the physical integrity of the print surface, but Secol Postcard Sleeves offer super clear vision to both sides and proven archival safety.

Postcard Sleeves are open on two short sides and welded on the two long ones. They are not punched. Postcard Sleeves are available in other sizes as Bespoke Service.

*For a Request Form turn to page 47.*

NAME	DIMENSIONS	FORMAT	PACK OF	REF NO
Postcard Sleeves	95 x 140mm	Standard Postcard	50	SLP95M140Y36H
Postcard Sleeves	95 x 140mm	Standard Postcard	100	SLP95M140Y36
Postcard Sleeves	110 x 155mm	Large Postcard	50	SLP110M155Y36H
Postcard Sleeves	110 x 155mm	Large Postcard	100	SLP110M155Y36
B.S. Postcard Sleeves	Bespoke	Other formats	100	BSSLP

## 3 Transleeves®



The Secol Polyester Transleeves® are the most effective means of preserving all photographic images including transparencies, negatives and prints, analogue or digital.

Each Transleeve® is precision manufactured from Acid-Free Secol archival Polyester, welded on two long sides and open on the short sides. They provide superb optical rendition and maximum visual access. Transleeves are available in Packs of 100. Packs of 50 are available as Bespoke Service.

NAME	DIMENSIONS	FORMAT	PACK OF	REF NO	APPLICATION
Transleeves®	66 x 64mm	2¼" x 2¼"	100	SL228228T	Display, Preserving & Storage of Photographic Images
Transleeves®	66 x 70mm	6 x 7cm	100	SL0607MT	Display, Preserving & Storage of Photographic Images
Transleeves®	66 x 89mm	2½ x 3½"	100	SL248348T	Display, Preserving & Storage of Photographic Images
Transleeves®	85 x 108mm	3¼ x 4¼"	100	SL328428T	Display, Preserving & Storage of Photographic Images
Transleeves®	93 x 120mm	9 x 12cm	100	SL0912MT	Display, Preserving & Storage of Photographic Images
Transleeves®	104 x 127mm	4 x 5"	100	SL0405T	Display, Preserving & Storage of Photographic Images



NAME	DIMENSIONS	FORMAT	PACK OF	REF NO	APPLICATION
Transleeves®	123 x 165mm	4¼ x 6½"	100	SL468648T	Display, Preserving & Storage of Photographic Images
Transleeves®	130 x 178mm	5 x 7"	100	SL0507T	Display, Preserving & Storage of Photographic Images
Transleeves®	168 x 216mm	6½ x 8½"	100	SL648848T	Display, Preserving & Storage of Photographic Images
Transleeves®	206 x 254mm	8 x 10"	100	SL0810T	Display, Preserving & Storage of Photographic Images
Transleeves®	214 x 298mm	A4	100	SLA4T	Display, Preserving & Storage of Photographic Images
Transleeves®	244 x 305mm	9½ x 12"	100	SL94812T	Display, Preserving & Storage of Photographic Images
Transleeves®	257 x 305mm	10 x 12"	100	SL1012T	Display, Preserving & Storage of Photographic Images
Transleeves®	282 x 355mm	11 x 14"	100	SL1114T	Display, Preserving & Storage of Photographic Images
Transleeves®	308 x 381mm	12 x 15"	100	SL1215T	Display, Preserving & Storage of Photographic Images
Transleeves®	308 x 406mm	12 x 16"	100	SL1216T	Display, Preserving & Storage of Photographic Images
Transleeves®	409 x 508mm	16 x 20"	100	SL1620T	Display, Preserving & Storage of Photographic Images
Transleeves®	512 x 660mm	20 x 26"	100	SL2026T	Display, Preserving & Storage of Photographic Images
B.S. Transleeves® Any			50	BSSLT	Display, Preserving & Storage of Photographic Images

#### 4 Colourview® Sleeves & Black Masks

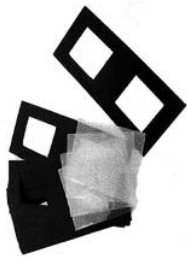

The Colourview® Sleeves are often preferred for the viewing of transparencies as they are glass clear at the front and soft diffused on the reverse to facilitate comfortable viewing without the need for a light box. Each Colourview® Sleeve is precision manufactured from acid-free Secol Polyester, welded on two long sides and open on the short sides. They provide superb optical rendition and maximum visual access.

Colourview® Sleeves are complete with the single-fold Black Masks that are designed for stylish appearance and total protection of single frame transparencies. The black frame and diffused background concentrate the eye clearly on the image providing a pleasing and professional finish. Colourview® Sleeves are available in packs of 25 with masks.

*For Colourview® Sleeves in Rolls turn to page 29.*

NAME	DIMENSIONS	FORMAT	PACK OF	REF NO	APPLICATION
Colourview® Sleeves	66x64mm	2¼x2¼"	100	SL228228C	Display, Preserving & Storage of Photographic Images
Colourview® Sleeves	66x70mm	6x7cm	100	SL0607MC	Display, Preserving & Storage of Photographic Images
Colourview® Sleeves	66x89mm	2½x3½"	100	SL248348C	Display, Preserving & Storage of Photographic Images
Colourview® Sleeves	93x120mm	9x12cm	100	SL0912MC	Display, Preserving & Storage of Photographic Images
Colourview® Sleeves	104x127mm	4x5"	100	SL0405C	Display, Preserving & Storage of Photographic Images
Colourview® Sleeves	130x178mm	5x7"	100	SL0507C	Display, Preserving & Storage of Photographic Images
Colourview® Sleeves	168x216mm	6½x8½"	100	SL648848C	Display, Preserving & Storage of Photographic Images
Colourview® Sleeves	206x254mm	8x10"	100	SL0810C	Display, Preserving & Storage of Photographic Images
Colourview® Sleeves	212x298mm	A4	100	SLA4C	Display, Preserving & Storage of Photographic Images
Colourview® Sleeves	244x305mm	9½x12"	100	SL94812C	Display, Preserving & Storage of Photographic Images
Colourview® Sleeves	409x508mm	16x20"	100	SL1620C	Display, Preserving & Storage of Photographic Images
B.S. Colourview® Sleeves		Any	50	BSSLC	Display, Preserving & Storage of Photographic Images
Colourview® Sleeves & Black Masks	4x5"/35mm		25	BM35M45	Display of Photographic Images
Colourview® Sleeves & Black Masks	4x5"/60x60mm		25	BM66M45	Display of Photographic Images
Colourview® Sleeves & Black Masks	4x5"/60x70mm		25	BM67M45	Display of Photographic Images
Colourview® Sleeves & Black Masks	6x7"/4x5"		25	BM4567	Display of Photographic Images

## 5 Trantec® Sleeves

Trantec® Sleeves were developed to allow faster and easier insertion of film or prints inside the protection of Secol archival 50 Micron polyester sleeving.

Each Trantec® Sleeve is welded on one long side and opens up completely for simple and safe insertion. The sleeve is then closed and a neat welded "captive flap" locks over the opposing edge to retain the contents safely inside and protected.

Trantec® Sleeves are available in a wide range of dimensions as Bespoke Service.

*For a Request Form turn to page 47.*

*For Trantec® Rolls turn to page 29.*

*For Standard Sleeves turn to page 23.*

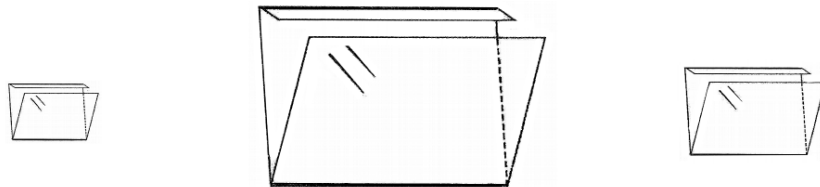

NAME	DIMENSIONS	FORMAT	PACK OF	REF NO	APPLICATION
Trantec® Sleeves	102x127mm	4x5"	50	TT0405T	Film, Prints, Cuts, Posters etc.
Trantec® Sleeves	121x165mm	4¾ x 6½"	50	TT468648T	Film, Prints, Cuts, Posters etc.
Trantec® Sleeves	127x178mm	5 x 7"	50	TT0507T	Film, Prints, Cuts, Posters etc.
Trantec® Sleeves	165x216mm	6½ x 8½"	50	TT648848T	Film, Prints, Cuts, Posters etc.
Trantec® Sleeves	203x254mm	8 x 10"	50	TT0810T	Film, Prints, Cuts, Posters etc.
Trantec® Sleeves	254x305mm	10 x 12"	50	TT1012T	Film, Prints, Cuts, Posters etc.
Trantec® Sleeves	305x381mm	12 x 15"	50	TT1215T	Film, Prints, Cuts, Posters etc.
Trantec® Sleeves	305x406mm	12 x 16"	50	TT1216T	Film, Prints, Cuts, Posters etc.
Trantec® Sleeves	406x508mm	16 x 20"	50	TT1620T	Film, Prints, Cuts, Posters etc.
Large Trantec® Units	605x845mm	A1/250 Micron	10	TTA1Y250	Maps, prints, drawings, posters
Large Trantec® Units	857x1207mm	A0/250 Micron	10	TTA0Y250	Maps, prints, drawings, posters

## 6 Stereo Sleeves



With the rarity and value of Stereo Prints, handling them for viewing can present a danger of damage. The Secol Polyester archival Stereo Sleeves can be left permanently in place to protect the stereo yet allow complete 100% visual access.

NAME	DIMENSIONS	CATEGORY	PACK OF	REF NO	APPLICATION
Stereo Sleeves	93 x 180mm	50 Micron	50	SL93180Y50H	Stereo Prints, Negatives
Stereo Sleeves	93 x 180mm	50 Micron	100	SL93180Y50	Stereo Prints, Negatives

## 7 Divided Index Sleeves without Cards

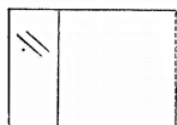

Versatile sleeves with one pocket for 5 x 4" images and the other pocket for a 44 x 105mm index card (not supplied) offer excellent solution for collection of prints where material is being constantly accessed and moved. This system ensures that the index always stay fixed to the material yet does not interfere with the visual access.

NAME	INTERNAL DIMENSIONS	CATEGORY	PACK OF	REF NO	APPLICATION
Divided Index Sleeves 105mm x 174mm	128x101mm + 42x101mm	50 Micron	50	SLP2105174Y50H	Prints + Cards
Divided Index Sleeves 105mm x 174mm	128x101mm + 42x101mm	50 Micron	100	SLP2105174Y50	Prints + Cards

## 8 Transleeve® Colourview® & Trantec® Rolls

Secol Glass Clear Transleeve® and clear at the front with frosted back Colourview® Sleeves are available in roll lengths for commercial or professional storage.

Sleeves are normally in 15mtr lengths, although other lengths are available by quotation. Please feel free to contact us for bespoke quotation.

The Trantec® Rolls with captive flap are particularly useful for panoramic shots or where it is convenient to protect a complete film without cutting it into frames.

Sleeve Rolls offer the means of protecting long strip formats without the possibility of stress or damage.

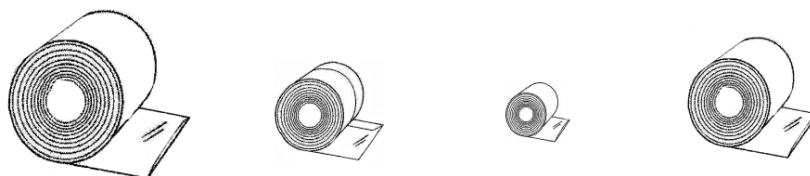

NAME	DIMENSIONS	FORMAT	PACK OF	REF NO	APPLICATION
Transleeve® Roll	41mm /W/x 15 metres	35mm film	1	RS35M15MT	Film, Panoramic, strip formats
Colourview® Roll	41mm /W/x 15 metres	35mm film	1	RS35M15MC	Film, Panoramic, strip formats
Transleeve® Roll	53mm /W/x 15 metres	35mm mounted	1	RS50M15MT	Film, Panoramic, strip formats
Colourview® Roll	53mm /W/x 15 metres	35mm mounted	1	RS50M15MC	Film, Panoramic, strip formats
Transleeve® Roll	66mm /W/x 15 metres	6cm film	1	RS22815MT	Film, Panoramic, strip formats
Colourview® Roll	66mm /W/x 15 metres	6cm film	1	RS22815MC	Film, Panoramic, strip formats
Transleeve® Roll	73mm /W/x 15 metres	70mm film	1	RS70M15MT	Film, Panoramic, strip formats
Colourview® Roll	73mm /W/x 15 metres	70mm film	1	RS70M15MC	Film, Panoramic, strip formats
Transleeve® Roll	74mm /W/x 15 metres	6x6 Mounts	1	RS06M15MT	Film, Panoramic, strip formats
Colourview® Roll	74mm /W/x 15 metres	6x6 Mounts	1	RS06M15MC	Film, Panoramic, strip formats
Trantec® Sleeve Roll	41mm /W/x 15 metres	35mm film	1	CF35M15MT	Film, Panoramic, strip formats
Trantec® Sleeve Roll	66mm /W/x 15 metres	60mm film	1	CF22815MT	Film, Panoramic, strip formats
Trantec® Sleeve Roll	72mm /W/x 15 metres	70mm film	1	CF70M15MT	Film, Panoramic, strip formats

## VI Slides, Films and Negatives - Preserving and Storage



The Secol Slides, Films & Negatives Protecting Storage system offers an ideal permanent storage medium for all photographic images.

Including unmounted film, slides, transparencies, negatives, glass plate negatives and prints.

### 1 Vertical and Hanging A-S A4 Format Pages

The Secol Vertical & Hanging A4 Format Pages give full archival protection against physical damage, surface reaction and atmospheric contamination and high optical clarity that enhances the appearance of the contents. All pages are a standard 317mm x 260mm overall with 4 holes.

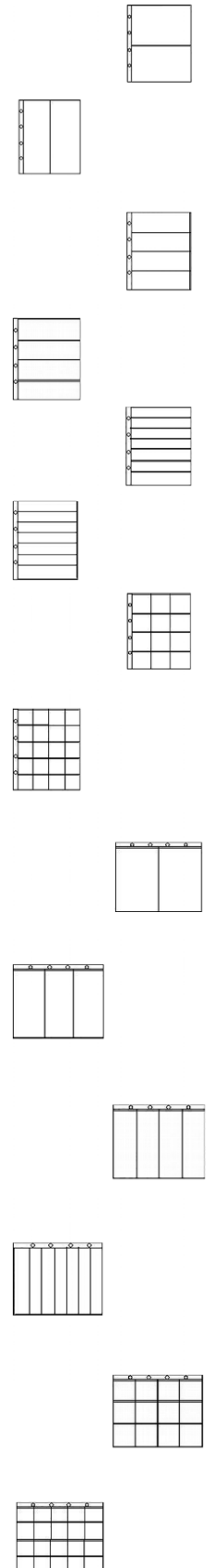

NAME	FORMAT	DIMENSIONS	PACK OF	REF NO
Standard A-S 2 Pockets Pages	260x317mm	2 pockets 233x154mm	25	AS201P2SEQ
Standard A-S 2 Pockets Pages	260x317mm	2 pockets 233x154mm	50	AS201P2SE
Standard A-S 2 Strip Pockets Pages	260x317mm	2 pockets 116x303mm	25	AS211P2SEQ
Standard A-S 2 Strip Pockets Pages	260x317mm	2 pockets 116x303mm	50	AS211P2SE
Standard A-S 4 Strip Pockets Pages	260x317mm	4 pockets 75x230mm	25	AS203S4SEQ
Standard A-S 4 Strip Pockets Pages	260x317mm	4 pockets 75x230mm	50	AS203S4SE
<b>AS 4 Strip Full-Width Open</b>	317x260mm	4 pockets 230x75mm	25	AS203S4SEQ
Pockets Pages	317x260mm	4 pockets 230x75mm	50	AS203S4SE
<b>AS 7 Strip Full-Width Open</b>	317x260mm	7 pockets 230x42mm	25	AS301S4SEQ
Pockets Pages	317x260mm	7 pockets 230x42mm	50	AS301S4SE
Standard A-S 7 Strip Pockets Pages	260x317mm	7 pockets: 42x230mm	25	AS204S7SEQ
Standard A-S 7 Strip Pockets Pages	260x317mm	7 pockets: 42x230mm	50	AS204S7SE
Standard A-S 12 Pockets Pages	260x317mm	12 pockets 76x66mm	25	AS207P12SEQ
Standard A-S 12 Pockets Pages	260x317mm	12 pockets 76x66mm	50	AS207P12SE
Standard A-S 20 Pockets Pages	260x317mm	20 pockets 57x54mm	25	AS205P20SEQ
Standard A-S 20 Pockets Pages	260x317mm	20 pockets 57x54mm	50	AS205P20SE
Hanging A-S 2 Pockets Pages	317x260mm	2 pockets 154x230mm	10	AS101P2X
Hanging A-S 2 Pockets Pages	317x260mm	2 pockets 154x230mm	25	AS101P2Q
Hanging A-S 2 Pockets Pages	317x260mm	2 pockets 154x230mm	50	AS101P2
Hanging A-S 3 Pockets Pages	317x260mm	3 pockets 102x230mm	10	AS108P3X
Hanging A-S 3 Pockets Pages	317x260mm	3 pockets 102x230mm	25	AS108P3Q
Hanging A-S 3 Pockets Pages	317x260mm	3 pockets 102x230mm	50	AS108P3
Hanging A-S 4 Strip Pockets Pages	317x260mm	4 Pockets 76 x 230mm	10	AS103S4X
Hanging A-S 4 Strip Pockets Pages	317x260mm	4 Pockets 76 x 230mm	25	AS103S4Q
Hanging A-S 4 Strip Pockets Pages	317x260mm	4 Pockets 76 x 230mm	50	AS103S4
Hanging A-S 7 Strip Pockets Pages	317x260mm	7 pockets: 42x230mm	10	AS204S7SEX
Hanging A-S 7 Strip Pockets Pages	317x260mm	7 pockets: 42x230mm	25	AS204S7SEQ
Hanging A-S 7 Strip Pockets Pages	317x260mm	7 pockets: 42x230mm	50	AS204S7SE
Hanging A-S 12 Pockets Pages	317x260mm	12 Pockets 76x76mm	10	AS107P12X
Hanging A-S 12 Pockets Pages	317x260mm	12 Pockets 76x76mm	25	AS107P12Q
Hanging A-S 12 Pockets Pages	317x260mm	12 Pockets 76x76mm	50	AS107P12
Hanging A-S 20 Pockets Pages	317x260mm	20 Pockets 60x54mm	10	AS105P20X
Hanging A-S 20 Pockets Pages	317x260mm	20 Pockets 60x54mm	25	AS105P20Q
Hanging A-S 20 Pockets Pages	317x260mm	20 Pockets 60x54mm	50	AS105P20

## 2 Contact Print Sheets

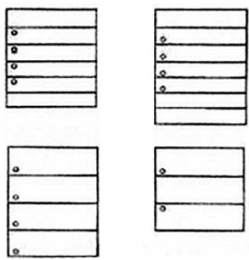

Polyester Contact Print Sheets are an ideal permanent storage medium for unmounted film. As their name implies, the high clarity of Secol Polyester enables contact printing of the entire sheet without the need for the film to leave its protective enclosure. Archival safety, high definition viewing and reduced handling time insure the safety of your images.

NAME	DIMENSIONS	ROWS	FRAMES	PACK OF	REF NO	APPLICATION
Contact Print Sheets	222x260mm	3x4	6cm	50	CS22834222H	Unmounted film
Contact Print Sheets	222x260mm	3x4	6cm	100	CS22834222	Unmounted film
Contact Print Sheets	275x260mm	6x6	3.5cm	50	CS35M66275H	Unmounted film
Contact Print Sheets	275x260mm	6x6	3.5cm	100	CS35M66275	Unmounted film
Contact Print Sheets	295x260mm	4x4	6cm	50	CS22844295H	Unmounted film
Contact Print Sheets	295x260mm	4x4	6cm	100	CS22844295	Unmounted film
Contact Print Sheets	320x260mm	7x6	3.5cm	50	CS35M76320H	Unmounted film
Contact Print Sheets	320x260mm	7x6	3.5cm	100	CS35M76320	Unmounted film

## 3 Transleeve® & Colourview® Divided Sheets

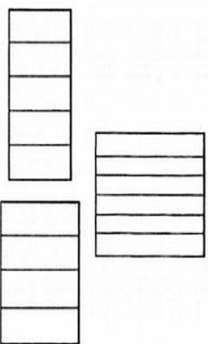

Divided Sheets are available in three useful formats for 35mm and 6cm film, and are the professional's choice for presentation of original film images to clients. They are unpunched. Divided Sheets are available in clear Polyester as Transleeve® or in Polyester with frosted back as Colourview® Sheets. Transleeve® and Colourview® Divided Sheets are available in packs of 100. Packs of 50 are available as Bespoke Service.

*For a Request Form turn to page 47.*

NAME	DIMENSIONS	ROWS	FRAMES	PACK OF	REF NO	APPLICATION
Transleeve® Divided Sheets	295x241mm	6	6	100	DS35M66295T	35mm film
Colourview® Divided Sheets	295x241mm	6	6	100	DS35M66295C	35mm film
Transleeve® Divided Sheets	310x190mm	4	3	100	DS22843310T	60mm film
Colourview® Divided Sheets	310x190mm	4	3	100	DS22843310C	60mm film
Transleeve® Divided Sheets	382x165mm	5	2	100	DS22852382T	60mm film
Colourview® Divided Sheets	382x165mm	5	2	100	DS22852382C	60mm film
B.S. Transleeve® Divided Sheets	295x241mm, 310x190mm, 382x165mm			50	BSDSMT	
B.S. Colourview® Divided Sheets	295x241mm, 310x190mm, 382x165mm			50	BSDSMT	

## 4 Tecs® Sleeves

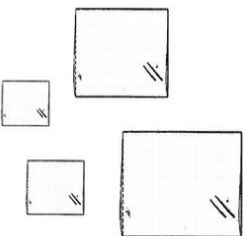

Secol TECS® Sleeves have been protecting mounted slides for generations. The optical clarity of polyester means that the snug fitting sleeve can be fitted to a mounted slide and left permanently in position.

Valuable original material can be handled regularly without the risk of scratches, grease or fingerprints contaminating the surfaces, yet still not compromise the viewing of the image. When you send out valuable original material for unsupervised handling, Secol TECS represent the very best insurance policy for the Photographer or Library.

Secol TECS® are available in all standard film sizes and will fit standard card and plastic mounts.

NAME	DIMENSIONS	ROWS	FRAMES	PACK OF	REF NO	APPLICATION
TECS® Sleeves	2 x 2"	2 x 2" Mount		100	TE0202	35mm film
TECS® Sleeves	2 x 2"	2 x 2" Mount		2000	TE0202X20	35mm film
TECS® Sleeves	70 x 70mm	70 x 70mm Mount		100	TE228228	60x 60mm
TECS® Sleeves	80 x 85mm	8 x 8.5cm Mount		100	TE0607M	60 x 70mm

## 5 Slide Security Pockets with Labels

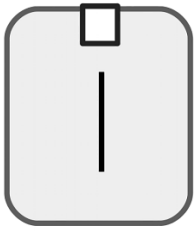

The Secol Sealed Pockets are designed to prevent the unauthorized reproduction of transparencies. Each pocket with a tamper-evident security label has a red line across the centre and the message "Fee payable if seal broken". Secure against unauthorized use, handling damage and of course fully archivally safe, your valuable images are clearly viewed and also protected to the highest standard with this Secol system. Tamper Evident Security Additional Labels in Pack of 500 are available as Bespoke Service.

*For a Request Form Turn to page 47. For Gloves turn to Accessories on page 42.*

NAME	DIMENSIONS	PACK OF	REF NO	APPLICATION
Slide Security Pockets with Labels	35 x 35mm	500	SCPRE0202LBH	Protection against unauthorised use
Slide Security Pockets with Labels	35 x 35mm	1000	SCPRE0202LB	Protection against unauthorised use
Tamper Evident Security Additional Labels	13 x 15mm	1000	LB13M51	Protection against unauthorised use
B.S. Tamper Evident Security Additional Labels	13 x 15mm	500	BSLB13M51H	Protection against unauthorised use

## 6 Four Flap Folders & Plain Sheets

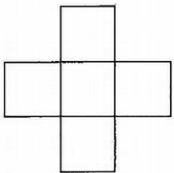

The Secol Four Flap Folders are manufactured from the highest specification photo-archival cotton fibre paper to provide a soft and safe barrier for protection of the glass substrate and the image thereon. The folders have 4 full size flaps. The unbuffered 80gsm material possesses a pH of approximately 6.7. Four Flap Folders are available in Packs of 100. Packs of 50 are available as Bespoke Service.

NAME	DIMENSIONS	FORMAT	PACK OF	REF NO	APPLICATION
Four Flap Folders	90 x 120mm	Quarter Plate	100	4FFL90120	Glass Plate Negatives
Four Flap Folders	100 x 130mm	4 x 5"	100	4FFL100130	Glass Plate Negatives
Four Flap Folders	122 x 165mm	Half Plate	100	4FFL122165	Glass Plate Negatives
Four Flap Folders	130 x 180mm	5 x 7"	100	4FFL130180	Glass Plate Negatives
Four Flap Folders	167 x 218mm	Whole Plate	100	4FFL167218	Glass Plate Negatives
B.S. Four Flap Folders	90x120mm, 100x130mm, 122x165mm, 130x180mm, 167x218mm		50	BS4FFL	Glass Plate Negatives
Cotton Photo Archival Paper	920 x 760mm	Uncut Plain Sheets	100	SHTCF920760G90	Glass Plate Negatives

## VII Archival Board Folders

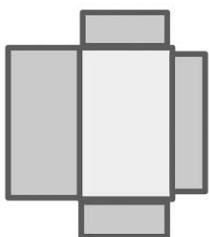

Archival Folders are manufactured from 100% wood free cellulose acid-free blue-grey board in 290 gsm weight.

The board is calcium carbonate buffered, slightly wet strength and has a pH value of 7.5 to 8.0.

Folders are manufactured in unglued format and they have a variety of uses in grouping and protecting documents and photographic images in conjunction with polyester enclosures (turn to page 13) and die-cut storage boxes (turn to page 37).

NAME	DIMENSIONS	CATEGORY	PACK OF	REF NO	APPLICATION/SUITABLE FOR
Archival Folders	170x245mm	290 gsm Board	10	STO17	Grouping, protecting documents, prints etc./polyester enclosures, boxes
Archival Folders	185x185mm	290 gsm Board	10	STO185	Grouping, protecting documents, prints, Single Vinyl etc./polyester enclosures, boxes
Archival Folders	220x280mm	290 gsm Board	10	STO22	Grouping, protecting documents, 8 x 10" prints/polyester enclosures, boxes
Archival Folders	230x310mm	290 gsm Board	10	STO23	Grouping, protecting A4 documents, prints etc./polyester enclosures, boxes
Archival Folders	270x355mm	290 gsm Board	10	STO27	Grouping, protecting documents, prints etc. /polyester enclosures, boxes
Archival Folders	310x310mm	290 gsm Board	10	STO31	Grouping, protecting documents, prints etc. /polyester enclosures, boxes
B.S. Archival Folders Bespoke		290 gsm Board	10	BSSTO	Grouping, protecting documents, prints etc. /polyester enclosures, boxes



## VIII CD, DVD and Vinyl Storage

The Secol CD, DVD & Vinyl Protecting Storage System supplies wide range of Polyester Pages, Pockets, Archival Folders, Binders, Portfolios, Index Cards, Boxes,

Drawers and Holders to meet various requirements for music and film Fans and Collectors.

Our products bring perfect solutions for indexing, archiving and protecting of CDs, DVDs and Black Discs.

Boxes are available in exact bespoke size to use space efficiently and minimize internal movement of discs so please do not hesitate to contact us with your requirements

### 1 A4 Format CD and DVD System Storage

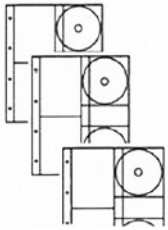

The clarity, strength and archival safety of A4 Format 2 CD & 2 Index Pockets Pages provide the perfect compromise between access and protection for Compact Discs. Each Page contents two Pockets 124 x 124 for CDs or DVDs and two Pockets 153 x 110mm for Index Cards.

Index Cards are available separately. These Two Sided Printed Index Cards in size 146 x 100mm perfectly fit A-S Pages for CDs. The Binders and Portfolios give the ultimate solution for bringing order, security and accessibility to CD & DVD stored in A-S Pages. Zip Case Portfolio without files offers a flexible, portable and totally safe solution for Compact Discs stored in A4 Format Pages.

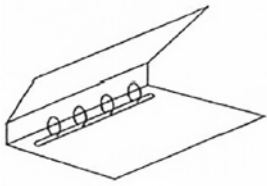

NAME	DIMENSIONS	FORMAT	PACK OF	REF. NO	SUITABLE FOR
2 CD & 2 Index Pockets Pages	2 x 124x124 & 2 x 153x110mm	317x260mm	10	ASCD2X	Index Cards
2 CD & 2 Index Pockets Pages	2 x 124x124 & 2 x 153x110mm	317x260mm	25	ASCD2Q	Index Cards
2 CD & 2 Index Pockets Pages	2 x 124x124 & 2 x 153x110mm	317x260mm	50	ASCD2	Index Cards
Double Sided Index Cards	146x100mm	146x100mm	50	ICD01	2 CD & 2 Index Pockets Pages
Boxboard Binder	333x310x57mm	A4	1	GBA4	2 CD & 2 Index Pockets Pages
Boxboard Binder	333x310x57mm	A4	1	GBA4T	2 CD & 2 Index Pockets Pages
Binder Maroon	340x300x60mm	A4	1	BD4RP340300	2 CD & 2 Index Pockets Pages
Slipcase for Binder	340x300x60mm	A4	1	SCBD340300	Binder Maroon
Standard A-S Binder Milskin	335x288x41mm	A4	1	COMA4	2 CD & 2 Index Pockets Pages
Standard A-S Binder Buckram	335x288x41mm	A4	1	ASCOMA4B	2 CD & 2 Index Pockets Pages
Collection Binder	355x310x55mm	A4	1	CCA4B	2 CD & 2 Index Pockets Pages
Zip Case Portfolio without Pages	350x285x40mm	A4	1	PFA4BKBS	2 CD & 2 Index Pockets Pages

### 2 CD and DVD Format Storage



The Secol CD & DVD Format Storage System offers an ideal permanent and safe storage solution for CD and DVD collections. All Pockets, Double Pockets, Indexed Pockets are manufactured from acid-free Polyester film that provides safe enclosure and high protective strength. Pockets are available in various thicknesses and perfectly protect against fingerprint marking, dust or dirt.

NAME	CATEGORY	DIMENSIONS	PACK OF	REF. NO	SUITABLE FOR
Archival Pockets	80 Micron	127x172mm	50	HCP127172	Flip-Top Boxes, Shelf Drawer, Boxes with Lids
Archival Pockets	80 Micron	127x172mm	100	HCP127172M	Flip-Top Boxes, Shelf Drawer, Boxes with Lids
Standard Pockets	50 Micron	127x127mm	25	P1127127Y50Q	Boxes with Lids, Shelf Drawer
Standard Pockets	50 Micron	127x127mm	50	P1127127Y50	Boxes with Lids, Shelf Drawer
Standard Pockets	75 Micron	127x127mm	25	P1127127Y75Q	Boxes with Lids, Shelf Drawer
Standard Pockets	75 Micron	127x127mm	50	P1127127Y75	Boxes with Lids, Shelf Drawer
Standard Pockets	100 Micron	127x127mm	25	P1127127Y100Q	Boxes with Lids, Shelf Drawer
Standard Pockets	100 Micron	127x127mm	50	P1127127Y100	Boxes with Lids, Shelf Drawer
Double Pockets	50 Micron	125x160mm	50	LEC3	Flip-Top Boxes, Shelf Drawer, Boxes with Lids
CD Pockets + Index Cards	80 Micron + Cards	44x122mm	25	DS02	Flip-Top Boxes, Shelf Drawer, Boxes with Lids



Secol solutions for bulk storage of CD and DVD collections offer flip-top storage boxes and a shelf drawer in ready formats. Flip-top boxes can hold approximately 50 pockets with discs and the index cards can be "flicked" through in seconds to locate a particular disc by numbers or key-words.

The archive Shelf Drawer holds up to 200 discs and will sit comfortably on standard shelving systems. The Lift-Off Lid Boxes can be manufacture in exact bespoke sizes so the samples just represent a small fraction of available items.

NAME	DIMENSIONS	CATEGORY	PACK OF	REF. NO	APPLICATION
CD & DVD Index Cards	120x155mm	Cards	50	ICD02	Disc Storage
Flip Top CD/DVD Storage Box	135x95x180mm	Maroon	1	DS01	Holds app 50 Discs
Flip Top CD/DVD Storage Box	135x95x180mm	Black	1	DS01B	Holds app 50 Discs
CD & DVD Shelf Drawer	140x145x380mm	Black Fibreboard	1	DS03	Holds up to 200 Discs
Lift-Off Lid Style Box	140x140x300mm	1300 Micron Blue-Grey Board	1	B05DS14M14BG13	Disc Storage
Lift-Off Lid Style Box	140x140x300mm	1300 Micron, Taupe Board	1	B05DS14M14TG13	Disc Storage
Lift-Off Lid Style Box	150x180x300mm	1300 Micron Blue-Grey Board	1	B05DS15M18BG13	Disc Storage
Lift-Off Lid Style Box	150x180x300mm	1300 Micron, Taupe Board	1	B05DS15M18TG13	Disc Storage

### 3 Vinyl Protection and Storage

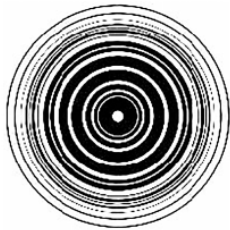

The Secol LPs and Singles Storage System gives the ultimate solution for bringing order, security, accessibility and presentation to collections of records in Vinyl formats. The system provides 80 Micron Polyester Pockets, board Folders and Holders to enable Black Discs to be protected and stored in a best possible way. The lift-off lid and vizi lift-off lid boxes can be manufacture in exact bespoke sizes so the samples just represent a small fraction of available items. Please feel free to contact us for Bespoke quotation.

NAME	DIMENSIONS	CATEGORY	PACK OF	REF. NO	APPLICATION
Archival Pockets	185x185mm	80 Micron Polyester	50	HCP185185	Vinyl Storage
Archival Pockets	185x185mm	80 Micron Polyester	100	HCP185185M	Vinyl Storage
Archival Pockets	310x310mm	80 Micron Polyester	50	HCP310310	Vinyl Storage
Archival Pockets	310x310mm	80 Micron Polyester	100	HCP310310M	Vinyl Storage
Archival Folders	185x185mm	290 gsm Board, Blue-grey	10	STO185	Vinyl Storage
Archival Folders	310x310mm	290 gsm Board, Blue-grey	10	STO310	Vinyl Storage
Vinyl Holder	195x200x95mm	1100 Micron, Blue-grey Board	1	SDH	Vinyl Storage
Vinyl Holder	195x200x95mm	1100 Micron, Taupe Board	1	SDHT	Vinyl Storage
Vinyl Holder	320x320x100mm	1100 Micron, Blue-grey Board	1	LPH Blue-grey	Vinyl Storage
Vinyl Holder	320x320x100mm	1100 Micron, Taupe Board	1	LPHT Taupe	Vinyl Storage
Lift-Off Lid Style Box	200x200x250mm	1300 Micron Blue-Grey Board	1	B05VS20M20BG13	Vinyl Storage
Lift-Off Lid Style Box	200x200x250mm	1300 Micron, Taupe Board	1	B05VS20M20TG13	Vinyl Storage
Lift-Off Lid Style Box	350x350x400mm	1300 Micron Blue-Grey Board	1	BV0VS35M35BG13	Vinyl Storage
Lift-Off Lid Style Box	350x350x400mm	1300 Micron, Taupe Board	1	B05VS35M35TG13	Vinyl Storage

## IX Acid-Free Boxes, Holders and Protectors

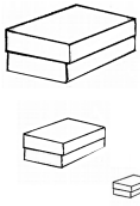

The Secol Boxes are manufactured from the highest grade acid-free Museum Boxboard and Die-Cut Corrugated material that combines exceptional strength with light weight and a neutral pH as a solution for bulk archives.

Boxes can be made in single piece clamshell" and upright style or using separate lift-off lid design. Standard Archival Boxes are supplied fully assembled and ready for immediate

use whilst Die-Cut Corrugated Boxes are supplied flat for self-assembly.

Boxes are available in exact bespoke size to use space efficiently and minimize internal movement of storage material.

They can be made for any individual requirements.

### 1 Standard Archive Boxes

Standard Archival Boxes are manufactured from the highest grade acid-free and lignin-free Museum Boxboard 1300 Micron in Taupe or Blue-Grey Colour. They are laminated white inside with EVA adhesive only and slightly Calcium Carbonate buffered. Boxes can be made in single piece "clamshell" design or using separate lift-off lids.

The Vizi Lift-Off Lid Style Boxes are made in two pieces with transparent lid. Boxes are supplied fully assembled and ready for immediate use.

Standard Boxes are available in a wide range of sizes to fit snugly with high clarity Polyester Pockets, Covers, Folders and Sleeves as they are perfect for storage, transportation and presentation. These smart and safe boxes will hold up to 100 prints and stack neatly on shelves building a well-protected fully indexed print archive.

Boxes can be also made for individual books, glass plate negatives, inkjet prints and anything that requires safe and long-term storage in solid boxes. Simply let us have dimensions and a quantity, and prices will be provided. Boxes in 1100 Micron also are available as bespoke service.

*For a Request Form Turn to page 47.*

#### CLAMSHELL STYLE BOXES

NAME	INTERNAL DIMENSIONS	CATEGORY	REF. NO	SUITABLE FOR/APPLICATION
Clamshell Style Box	203x254mm/8x10"	1300 Micron, Blue-Grey Boxboard	B011008BG13	Polyester enclosures /Prints, documents etc.
Clamshell Style Box	203x254mm/8x10"	1300 Micron, Taupe Boxboard	B011008TG13	Polyester enclosures/Prints, documents etc.
Clamshell Style Box	230x315xmm/A4	1300 Micron, Blue-Grey Boxboard	B01A4BG13	Polyester enclosures/Prints, documents etc.
Clamshell Style Box	230x315xmm/A4	1300 Micron, Taupe Boxboard	B01A4TG13	Polyester enclosures/Prints, documents etc.
Clamshell Style Box	305x254mm/12x10"	1300 Micron, Blue-Grey Boxboard	B011210BG13	Polyester enclosures/Prints, documents etc.
Clamshell Style Box	305x254mm/12x10"	1300 Micron, Taupe Boxboard	B011210TG13	Polyester enclosures/Prints, documents etc.
Clamshell Style Box	415x315xmm/16x12"	1300 Micron, Blue-Grey Boxboard	B011216BG13	Polyester enclosures/Prints, documents etc.
Clamshell Style Box	415x315xmm/16x12"	1300 Micron, Taupe Boxboard	B011216TG13	Polyester enclosures/Prints, documents etc.
Clamshell Style Box	435 x 325mm/A3	1300 Micron, Blue-Grey Boxboard	B01A3BG13	Polyester enclosures/Prints, documents etc.
Clamshell Style Box	435x325mm/A3	1300 Micron, Taupe Boxboard	B01A3TG13	Polyester enclosures/Prints, documents etc.
Clamshell Style Box	495x340mm/A3+	1300 Micron, Blue-Grey Boxboard	B01A3+BG13	Polyester enclosures/Prints, documents etc.
Clamshell Style Box	495x340mm/A3+	1300 Micron, Taupe Boxboard	B01A3+TG13	Polyester enclosures/Prints, documents etc.
Clamshell Style Box	508x406mm/20x16"	1300 Micron, Blue-Grey Boxboard	B012016BG13	Polyester enclosures/Prints, documents etc.
Clamshell Style Box	508x406mm/20x16"	1300 Micron, Taupe Boxboard	B012016TG13	Polyester enclosures/Prints, documents etc.
Clamshell Style Box	610x440mm/A2	1300 Micron, Blue-Grey Boxboard	B01A2BG13	Polyester enclosures/Prints, documents etc.
Clamshell Style Box	610x440mm/A2	1300 Micron, Taupe Boxboard	B01A2TG13	Polyester enclosure/Prints, documents etc.
B.S. Archival Box	Bespoke	1300 Micron, Blue-Grey Boxboard	BSB01BG13	Bespoke Service
B.S. Archival Box	Bespoke	1300 Micron, Taupe Boxboard	BSB01TG13	Bespoke Service
B.S. Archival Box	Bespoke	1100 Micron, Blue-Grey Boxboard	BSB01BG11	Bespoke Service
B.S. Archival Box	Bespoke	1100 Micron, Taupe Boxboard	BSB01TG11	Bespoke Service
B.S. Mounted Slide Box	Bespoke	1300 Micron, Blue-Grey Boxboard	BSMSBBG	Mounted Slides
B.S. Mounted Slide Box	Bespoke	1300 Micron, Taupe Boxboard	BSMSBT	Mounted Slides

## LIFT-OFF LID STYLE BOXES

NAME	INTERNAL DIMENSIONS	CATEGORY	REF. NO	SUITABLE FOR/APPLICATION
Lift-Off Lid Style Box	140x140x300mm	1300 Micron Blue-Grey Board	B05DS14M14BG13	Disc Storage
Lift-Off Lid Style Box	140x140x300mm	1300 Micron, Taupe Board	B05DS14M14TG13	Disc Storage
Lift-Off Lid Style Box	150x180x300mm	1300 Micron Blue-Grey Board	B05DS15M18BG13	Disc Storage
Lift-Off Lid Style Box	150x180x300mm	1300 Micron, Taupe Board	B05DS15M18TG13	Disc Storage
Lift-Off Lid Style Box	200x200x250mm	1300 Micron Blue-Grey Board	B05VS20M20BG13	Vinyl Storage
Lift-Off Lid Style Box	200x200x250mm	1300 Micron, Taupe Board	B05VS20M20TG13	Vinyl Storage
Lift-Off Lid Style Box	350x350x400mm	1300 Micron Blue-Grey Board	B05VS35M35BG13	Vinyl Storage
Lift-Off Lid Style Box	350x350x400mm	1300 Micron, Taupe Board	B05VS35M35TG13	Vinyl Storage
Lift-Off Lid Style Box	203x254mm/8x10"	1300 Micron, Blue-Grey Boxboard	B051008BG13	Polyester enclosures/Prints, documents etc.
Lift-Off Lid Style Box	203x254mm/8x10"	1300 Micron, Taupe Boxboard	B051008TG13	Polyester enclosures/Prints, documents etc.
Lift-Off Lid Style Box	230x315xmm/A4	1300 Micron, Blue-Grey Boxboard	B05A4BG13	Polyester enclosures/Prints, documents etc.
Lift-Off Lid Style Box	230x315xmm/A4	1300 Micron, Taupe Boxboard	B05A4TG13	Polyester enclosures/Prints, documents etc.
Lift-Off Lid Style Box	305x254mm/12x10"	1300 Micron, Blue-Grey Boxboard	B051210BG13	Polyester enclosures/Prints, documents etc.
Lift-Off Lid Style Box	305x254mm/12x10"	1300 Micron, Taupe Boxboard	B051210TG13	Polyester enclosures/Prints, documents etc.
Lift-Off Lid Style Box	415x315xmm/16x12"	1300 Micron, Blue-Grey Boxboard	B051216BG13	Polyester enclosures/Prints, documents etc.
Lift-Off Lid Style Box	415x315xmm/16x12"	1300 Micron, Taupe Boxboard	B051216TG13	Polyester enclosures/Prints, documents etc.
Lift-Off Lid Style Box	435 x 325mm/A3	1300 Micron, Blue-Grey Boxboard	B05A3BG13	Polyester enclosures/Prints, documents etc.
Lift-Off Lid Style Box	435x325mm/A3	1300 Micron, Taupe Boxboard	B05A3TG13	Polyester enclosures/Prints, documents etc.
Lift-Off Lid Style Box	495x340mm/A3+	1300 Micron, Blue-Grey Boxboard	B05A3+BG13	Polyester enclosures/Prints, documents etc.
Lift-Off Lid Style Box	495x340mm/A3+	1300 Micron, Taupe Boxboard	B05A3+TG13	Polyester enclosures/Prints, documents etc.
Lift-Off Lid Style Box	508x406mm/20x16"	1300 Micron, Blue-Grey Boxboard	B052016BG13	Polyester enclosures/Prints, documents etc.
Lift-Off Lid Style Box	508x406mm/20x16"	1300 Micron, Taupe Boxboard	B052016TG13	Polyester enclosures/Prints, documents etc.
Lift-Off Lid Style Box	610x440mm/A2	1300 Micron, Blue-Grey Boxboard	B05A2BG13	Polyester enclosures/Prints, documents etc.
Lift-Off Lid Style Box	610x440mm/A2	1300 Micron, Taupe Boxboard	B05A2TG13	Polyester enclosures/Prints, documents etc.
B.S. Archival Box & Lid	Bespoke	1300 Micron Blue-Grey Boxboard	BSB05BG13	Bespoke Service
B.S. Archival Box & Lid	Bespoke	1300 Micron Taupe Boxboard	BSB05TG13	Bespoke Service
B.S. Archival Box & Lid	Bespoke	1100 Micron Blue-Grey Boxboard	BSB05BG11	Bespoke Service
B.S. Archival Box & Lid	Bespoke	1100 Micron Taupe Boxboard	BSB05TG11	Bespoke Service

## VIZI LIFT-OFF LID STYLE BOXES

NAME	INTERNAL DIMENSIONS	CATEGORY	REF. NO	SUITABLE FOR/APPLICATION
Vizi Lift-Off Lid Style Box	140x140x300mm	1300 Micron Blue-Grey Board	BV5DS14M14BG13	Disc Storage
Vizi Lift-Off Lid Style Box	140x140x300mm	1300 Micron, Taupe Board	BV5DS14M14TG13	Disc Storage
Vizi Lift-Off Lid Style Box	150x180x300mm	1300 Micron Blue-Grey Board	BV5DS15M18BG13	Disc Storage
Vizi Lift-Off Lid Style Box	150x180x300mm	1300 Micron, Taupe Board	BV5DS15M18TG13	Disc Storage
Vizi Lift-Off Lid Style Box	200x200x250mm	1300 Micron Blue-Grey Board	BV5VS20M20BG13	Vinyl Storage
Vizi Lift-Off Lid Style Box	200x200x250mm	1300 Micron, Taupe Board	BV5VS20M20TG13	Vinyl Storage
Vizi Lift-Off Lid Style Box	350x350x400mm	1300 Micron Blue-Grey Board	BV5VS35M35BG13	Vinyl Storage
Vizi Lift-Off Lid Style Box	350x350x400mm	1300 Micron, Taupe Board	BV5VS35M35TG13	Vinyl Storage
Vizi Lift-Off Lid Style Box	203x254mm/8x10"	1300 Micron, Blue-Grey Boxboard	BV51008BG13	Polyester enclosures/Prints, documents etc.
Vizi Lift-Off Lid Style Box	203x254mm/8x10"	1300 Micron, Taupe Boxboard	BV51008TG13	Polyester enclosures/Prints, documents etc.

NAME	INTERNAL DIMENSIONS	CATEGORY	REF. NO	SUITABLE FOR/APPLICATION
Vizi Lift-Off Lid Style Box	230x315xmm/A4	1300 Micron, Blue-Grey Boxboard	BV5A4BG13	Polyester enclosures/Prints, documents etc.
Vizi Lift-Off Lid Style Box	230x315xmm/A4	1300 Micron, Taupe Boxboard	BV5A4TG13	Polyester enclosures/Prints, documents etc.
Vizi Lift-Off Lid Style Box	305x254mm/12x10"	1300 Micron, Blue-Grey Boxboard	BV51210BG13	Polyester enclosures/Prints, documents etc.
Vizi Lift-Off Lid Style Box	305x254mm/12x10"	1300 Micron, Taupe Boxboard	BV51210TG13	Polyester enclosures/Prints, documents etc.
Vizi Lift-Off Lid Style Box	415x315xmm/16x12"	1300 Micron, Blue-Grey Boxboard	BV51216BG13	Polyester enclosures/Prints, documents etc.
Vizi Lift-Off Lid Style Box	415x315xmm/16x12"	1300 Micron, Taupe Boxboard	BV51216TG13	Polyester enclosures/Prints, documents etc.
Vizi Lift-Off Lid Style Box	435 x 325mm/A3	1300 Micron, Blue-Grey Boxboard	BV5A3BG13	Polyester enclosures/Prints, documents etc.
Vizi Lift-Off Lid Style Box	435x325mm/A3	1300 Micron, Taupe Boxboard	BV5A3TG13	Polyester enclosures/Prints, documents etc.
Vizi Lift-Off Lid Style Box	495x340mm/A3+	1300 Micron, Blue-Grey Boxboard	BV5A3+BG13	Polyester enclosures/Prints, documents etc.
Vizi Lift-Off Lid Style Box	495x340mm/A3+	1300 Micron, Taupe Boxboard	BV5A3+TG13	Polyester enclosures/Prints, documents etc.
Vizi Lift-Off Lid Style Box	508x406mm/20x16"	1300 Micron, Blue-Grey Boxboard	BV52016BG13	Polyester enclosures/Prints, documents etc.
Vizi Lift-Off Lid Style Box	508x406mm/20x16"	1300 Micron, Taupe Boxboard	BV52016TG13	Polyester enclosures/Prints, documents etc.
Vizi Lift-Off Lid Style Box	610x440mm/A2	1300 Micron, Blue-Grey Boxboard	BV5A2BG13	Polyester enclosures/Prints, documents etc.
Vizi Lift-Off Lid Style Box	610x440mm/A2	1300 Micron, Taupe Boxboard	BV5A2TG13	Polyester enclosures/Prints, documents etc.
B.S. Vizi Archival Box & Lid	Bespoke	1300 Micron Blue-Grey Boxboard	BSB05BG13	Bespoke Service
B.S. Vizi Archival Box & Lid	Bespoke	1300 Micron Taupe Boxboard	BSB05TG13	Bespoke Service
B.S. Vizi Archival Box & Lid	Bespoke	1100 Micron Blue-Grey Boxboard	BSB05BG11	Bespoke Service
B.S. Vizi Archival Box & Lid	Bespoke	1100 Micron Taupe Boxboard	BSB05TG11	Bespoke Service

## 2 Die-Cut Corrugated Boxes



Die-Cut Corrugated Boxes are practical solution for bulk archives. They provide safe, long-term storage for items up to A1 size. The corrugated material in a light tan colour is acid-free and combines exceptional high strength with light weight. Boxes are supplied completely flat for self-assembly so they save significant space prior to installation.

They are manufactured in two styles, Clamshell and Upright. The Clamshell style is designed to be used in conjunction with Polyester Pockets, Covers, etc. Labels and Spine Label Holders. Their design means there are four layers of corrugated board around 3 sides so the clamshell boxes can be stored comfortably in a self-supporting stack.

The Upright style is designed for material in files or folders stored upright. The Corrugated Boxes are all supplied in packs of 10.



NAME	INTERNAL DIMENSIONS	CATEGORY	REF. NO	SUITABLE FOR/APPLICATION
Clamshell Boxes	315x245x60mm/A4	Die-Cut Corrugated Board	BA31524560	Polyester enclosures/Bulk archives
Clamshell Boxes	415x315x60mm/12 x 16"	Die-Cut Corrugated Board	BA41531560	Polyester pockets, sleeves etc./Bulk archives
Clamshell Boxes	435 x 320 x 60mm/A3	Die-Cut Corrugated Board	BA43532060	Polyester pockets, sleeves etc./Bulk archives
Clamshell Boxes	610x440x60mm/A2	Die-Cut Corrugated Board	BA61044060	Polyester pockets, sleeves etc./Bulk archives
Clamshell Boxes	855x615x60mm/A1	Die-Cut Corrugated Board	BA85561560	Polyester pockets, sleeves etc./Bulk archives
Upright Boxes	385x114x260mm/Foolscap	Die-Cut Corrugated Board	BA385114260	Material in files, folders etc./Bulk archives

### 3 Memory Boxes

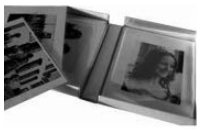

The Memory Box with 25 beautifully clear Polyester Pockets is designed for those special occasions such as Christenings, Weddings, Birthdays and Anniversaries. The system is based on a hand-made, museum style box covered in textured ivory bookcloth and lined with acid-free heritage paper.

The pockets are not fixed into the box, so clients can handle and arrange the images as they like, whilst the stunning display grade polyester, ensures that the images are well protected at all times. Acid free Mounting Inserts (see page 40) can also be added for using smaller prints within a visual frame.

NAME	DIMENSIONS	CATEGORY	REF. NO	SUITABLE FOR/APPLICATION
Memory Box & 25 Pockets	240x315x38mm/A4	Ivory Bookcloth, Polyester	WBA4IV	Presentation of special occasions, Storage
Memory Box & 25 Assorted Pockets	240x315x38mm/A4	Ivory Bookcloth, Polyester	WBA4IVAP	Presentation of special occasions, Storage
Memory Box without Pockets	240x315x38mm/A4	Ivory Bookcloth	WBA4IVNP	Presentation of special occasions, Storage

### 4 Presentation Boxes

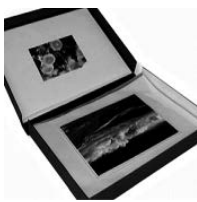

Professional Portfolio Box is hand-made from acid-free archival boxboard and covered in hard-wearing black library buckram cloth, bonded with neutral pH acrylic adhesive. It is lined with a protective white barrier and features a double clamshell edge which fits snugly together.

For each format there is a perfectly matched polyester pocket to fit exactly inside the protective frame of the box. When closed the portfolio box shields valuable prints from light, dust, dirt and harmful atmospheric gases. When opened, the special drop-spine construction allows the unit to lay perfectly flat for individual inspection of each print. Each box portfolio comes with 25 pockets if required, but will accommodate a further 50 pockets.

NAME	DIMENSIONS	CATEGORY	REF. NO	APPLICATION
Portfolio System. Box & 25 Pockets	240x315x38mm/A4	Library Buckram Cloth, Polyester	BFA4BKB	Presentation, Storage
Portfolio System. Box & 25 Covers	240x315x38mm/A4	Library Buckram Cloth, Polyester	BFCA4BKB	Presentation, Storage
Portfolio System. Box & 25 Pockets	318x435x38mm/A3	Library Buckram Cloth, Polyester	BFA3BKB	Presentation, Storage
Portfolio System. Box & 25 Covers	318x435x38mm/A3	Library Buckram Cloth, Polyester	BFCA3BKB	Presentation, Storage

### 5 Archive Holders and Corner Protectors



The Archive Holders are manufactured in acid-free and high strength material as a solution for bulk storage. They allow systematic and accessible control over an expanding collection. The Archive Holders are available in a wide range of sizes to fit various formats and numbers of storage issues.

The Corner Protectors are also manufactured in acid-free and high strength material to protect plain pictured canvas, frames, books and other delicate items. They are also available in a wide range of sizes to fit various requirements. The samples of holders and corner protectors represent a small fraction of available sizes.

NAME	DIMENSIONS	CATEGORY	PACK OF	REF. NO	APPLICATION
Corner Protectors	105x155x50mm	Blue-Grey Board	4	CP10515550/4	Corner protection of frames, canvas, books etc.
Corner Protectors	105 x 155 x 50mm	Blue-Grey Board	20	CP10515550/20	Corner protection of frames, canvas, books etc.
Corner Protectors	205 x 295 x 30mm	Blue-Grey Board	4	CP20529530/4	Corner protection of frames, canvas, books etc.
Corner Protectors	205 x 295 x 30mm	Blue-Grey Board	20	CP20529530/20	Corner protection of frames, canvas, books etc.
Archive Holder A4	250x320x85mm	Blue-Grey Board	1	CMHA4	Long term storage of leaflets, booklets, magazines etc.
Archive Holder A4	250x320x85mm	Taupe Board	1	CMHA4T	Long term storage of leaflets, booklets, magazines etc.
Archive Holder A5	160x220x65mm	Blue-Grey Board	1	CMHA45	Long term storage of leaflets, booklets, magazines etc.
Archive Holder A5	160x220x65mm	Taupe Board	1	CMHA45T	Long term storage of leaflets, booklets, magazines etc.

## XI Large Polyester Enclosures and Storage

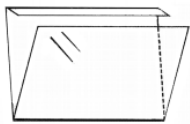

The A0 Standard Pockets, Covers, Folders & Sleeves fit perfectly in a whole drawer, or two A1 items can be fitted side by side with an optional drawer divider.

Trantec® Protection Units are manufactured in 250 Micron Polyester and are perfect solution for Heavy Duty requirements.

The large sizes of Polyester enclosures are completely inert and Acid-Free Polyester film. They are available in packs of 10.

*For mounting strips and tapes turn to Mounting Solutions on page 41.*

### 1 Pockets, Folders, Covers and Sleeves

NAME	DIMENSIONS	CATEGORY	REF. NO	SUITABLE FOR/APPLICATION
Trantec® Protection Units	605x845mm/A1	250 Micron Polyester	TTA1Y250	Plan Chests/Protection of larger prints, maps, etc.
Trantec® Protection Units	857x1207mm/A0	250 Micron Polyester	TTA0Y250	Plan Chests/Protection of larger prints, maps, etc.
Standard Pockets	775x1025mm/30½x 40¼"	100 Micron Polyester	P17751025Y100	Plan Chests/Standard O.S. map
Standard Pockets A0	857x1207mm/33¾x 47½"	100 Micron Polyester	P18571207Y100	Plan Chests/A0 Maps, posters etc.
Standard Covers	775x1025mm/30½x 40¼"	100 Micron Polyester	C7751025Y100	Plan Chests/Standard O.S. map
Standard Covers A0	857x1207mm/33¾x 47½"	100 Micron Polyester	P18571207Y100	Plan Chests/A0 Maps, posters etc.
Standard Folders	775x1025mm/30½x 40¼"	100 Micron Polyester	F7751025Y100	Plan Chests/Standard O.S. map
Standard Folders A0	857x1207mm/33¾x 47½"	100 Micron Polyester	P18571207Y100	Plan Chests/A0 Maps, posters etc.
Standard Sleeves	775x1025mm/30½x 40¼"	100 Micron Polyester	S7751025Y100	Plan Chests/Standard O.S. map
Standard Sleeves A0	857x1207mm/33¾x 47½"	100 Micron Polyester	P18571207Y100	Plan Chests/A0 Maps, posters etc.

### 2 Horizontal Plan Chests



For storage of maps, plans, drawings and prints a Secol horizontal plan chest makes an ideal and secure environment for our polyester storage products. Based on A0 size drawers, these solid lockable cabinets in grey steel feature high quality ball-bearing extension slides to produce the smoothest of movements even when fully laden.

Each drawer possesses an index pocket for identification, and either 8 or 12 drawer versions fit in the same unit size, with the option of extension units to produce a double height combination chest. Plan Chests are available in red, grey, blue, black and many other colours.

*For a Request Form Turn to page 47.*

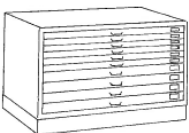

NAME	DIMENSIONS OVRALL/INTERNAL	CATEGORY	REF. NO	SUITABLE FOR/APPLICATION
Plan Chest	1367x947x875mm/1257x913x65mm	8 Drawer	7350	A0, A1 format polyester items/Storage of maps, charts, posters etc.
Plan Chest	1367x947x875mm/1257x913x37mm	12 Drawer	7352	A0, A1 format polyester items/Storage of maps, charts, posters etc.
Plan Chest Extension	1367x947x705mm/1257x913x65mm	8 Drawer	7354	A0, A1 format polyester items/Storage of maps, charts, posters etc.
Plan Chest Extension	1367x947x705mm/1257x913x37mm	12 Drawer	7356	A0, A1 format polyester items/Storage of maps, charts, posters etc.
Drawer Dividers	500 x 60mm	Deep, 8 Drawers	7362	A0, A1 format polyester items/Storage of maps, charts, posters etc.
Drawer Dividers	400 x 30mm	Shallow, 12 Drawers	7363	A0, A1 format polyester items/Storage of maps, charts, posters etc.

## X Mounting Solutions

Secol provide the ideal material for mounting all kinds of paper and photographic presentations in books or on display.

Polyester film is glass clear for minimal visual intrusion, whilst at the same time archivally safe for direct and long-term contact with precious materials.

That is why the Mounting Solutions offer a secure archival structure for variety of different formats of material.

### 1 Mounting Board, Tissue and Border Mounts

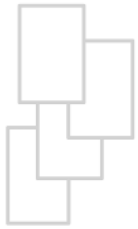

**Mounting Inserts** are made from heavy-weight 315gsm board to provide a safe and stable base for mounting up all kinds of materials with the additional benefit that they can be annotated and labelled to maintain the complete story. They are ideal for use with Polyester A-S Pages, Binder & Security Style Pages, Standard and Comprehensive Pockets to securely store and display any precious collections of documents and photographs. The acid free board is ivory in colour, with slight calcium carbonate buffer to neutralize residual acidic material.



**Mounting Board** is 100% cotton fibre board and calcium carbonate buffered and surface sized. It is available in two thicknesses 110 and 160 gsm, in cream or black colour. The board is ideal for mounting and display work: drawings, photographs, prints and general conservation work as well.

Acid free **Board Tissue** is also 100% cotton fibre board and calcium carbonate buffered and surface sized. It is available in two sizes for various archiving applications.



**Border Mounts** in black colour, are available in many various sizes and shapes as bespoke service.

*For a Request Form Turn to page 47.*



NAME	DIMENSIONS	CATEGORY	PACK OF	REF. NO	SUITABLE FOR/APPLICATION
Mounting A4 Inserts	215 x 300mm	315 gsm Ivory Board	25	MIWA4Q	Polyester pockets, sleeves, etc./Mounting base
Mounting A4 Inserts	215 x 300mm	315 gsm Ivory Board	50	MIWA4	Polyester pockets, sleeves, etc./Mounting base
Mounting A3 Inserts	305 x 420mm	315 gsm Ivory Board	25	MIWA3Q	Polyester pockets, sleeves, etc./Mounting base
Mounting A3 Inserts	305 x 420mm	315 gsm Ivory Board	50	MIWA3	Polyester pockets, sleeves, etc./Mounting base
Mounting A2 Inserts	430 x 600mm	315 gsm Ivory Board	25	MIWA2Q	Polyester pockets, sleeves, etc./Mounting base
Mounting A2 Inserts	430 x 600mm	315 gsm Ivory Board	50	MIWA2	Polyester pockets, sleeves, etc./Mounting base
Mountboard	550 x 750mm	160 gsm, Black	1	AFBBL550750G160	V Mounts, Corner Strips, Tapes/ Mounting, display of work
Mountboard	830 x 1140mm	1100 Micron, Cream	1	AB3345Y1100	V Mounts, Corner Strips, Tapes/ Mounting, display of work
Mountboard	830 x 1140mm	1650 Micron, Cream	1	AB3345Y1650	V Mounts, Corner Strips, Tapes/ Mounting, display of work
Board Tissue	500 x 750mm	18 gsm Cream Board	500	AFT500750G18	Wrapping, interleaving
Board Tissue	750 x 1000mm	18 gsm Cream Board	500	AFT7501000G18	Wrapping, interleaving
B.S. Archival Border Mounts	Bespoke	Acid-free, Black Board	10	BSABM	Decorative edging



## 2 Mounting Strips and Tapes

The **V-Mount Strips** can be cut and applied in any length to suit the particular material on Mounting Inserts or plain album pages. The mounted item is positively held within the V-shape with contact to polyester alone, yet can be removed safely at any stage if required. The unique clarity of Polyester film ensures the mount is discreet and unobtrusive.

**Single & Double Sided Tapes** are manufactured on a very thin carrier film of Polyester. They are exceptionally stable, so can be used for permanent mounting of items or fixing polyester display Pockets, Covers, Folders and Sleeves onto Mounting Inserts.

**Book Mark Strips** are ideal for use in book presentation work. They can be readily pre-folded to take up the exact shape of the book. Individual lengths can be gently folded round the volume to ensure it stays open where required. The 50 Micron Strip is light enough for the most delicate of requirements.

The **Philatelic Mounts** are designed as a complete all-round enclosure. They offer a complete archival protection to mounting and displaying stamps. Each 217mm philatelic strip can be cut to the widths desired. Each stamp is protected inside the polyester envelope which can be adhered to an album page using its built-in dry-mount peel off strip.

The stamp is hinged and protected completely, yet can be removed from the mount if required without any harm. The advantages are also an unrivalled clarity, total museum grade security and a complete absence of water for the dry-mounting.

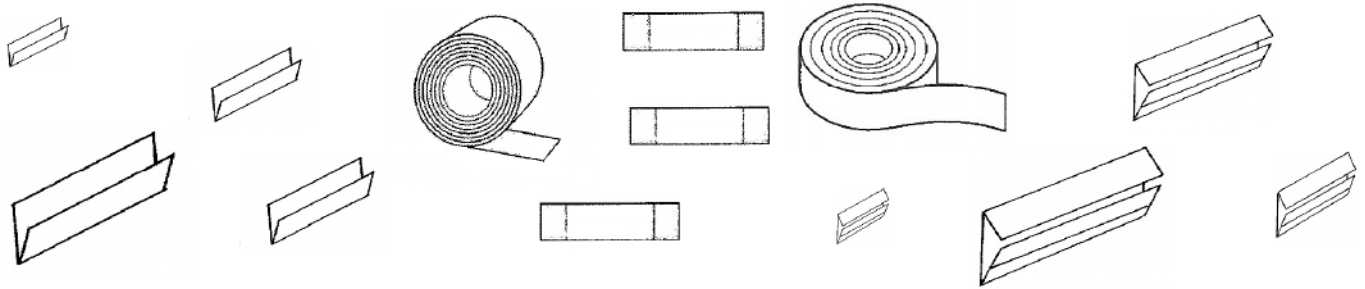

NAME	DIMENSIONS	CATEGORY	PACK OF	REF. NO	SUITABLE FOR/APPLICATION
V Mount Strips	8 x 200mm	75 Micron Polyester	25	AMTSTV814Y75	Mounting Inserts, Albums, etc.
B.S. V Mount Welded Rolls	Bespoke	75 Micron Polyester	Any	BSAMTSTV814Y75	Bespoke requirements
Mounting Corner Strips	11 x 38mm	75 Micron Polyester	100	MCS11M38	Mounting Inserts, Albums/ Positioning, framing, etc.
Mounting Corner Strips	20 x 100mm	75 Micron Polyester	100	MCS20M100	Mounting Inserts, Albums/ Positioning, framing, etc.
Single Sided Tape	25mm x 66m	Polyester/Acrylic	1 Roll	PA25M66	Mounting Inserts, Boards, Polyester sheets/ Permanent mounting
Double Sided Tape	6mm x 50m	Polyester/Acrylic	1 Roll	ARTP6M50	Mounting Inserts, Boards, Polyester sheets/ Permanent mounting
Double Sided Tape	12mm x 50m	Polyester/Acrylic	1 Roll	ARTP12M50	Mounting Inserts, Boards, Polyester sheets/ Permanent mounting
Book Mark Strip	13mm x 25m	50 Micron Polyester	1 Roll	BMS13M25Y50	Display conservation of books, Various delicate requirements
Book Mark Strip	13mm x 25m	125 Micron Polyester	1 Roll	BMS13M25Y125	Display, Conservation of books

### STAMTEC MOUNTS

Stamtec Mounts	24 x 217mm	75 Micron Polyester	10	STAMT24217Y75	GB Defin, Pre 1967 Commems
Stamtec Mounts	26 x 217mm	75 Micron Polyester	10	STAMT26217Y75	USA Commems
Stamtec Mounts	30 x 217mm	75 Micron Polyester	10	STAMT30217Y75	GB Commems Landscape
Stamtec Mounts	31 x 217mm	75 Micron Polyester	10	STAMT31217Y75	Channel Islands, High Values
Stamtec Mounts	35 x 217mm	75 Micron Polyester	10	STAMT35217Y75	Millennium Issues
Stamtec Mounts	41 x 217mm	75 Micron Polyester	10	STAMT41217Y75	GB Commems Portrait
Stamtec Mounts	48 x 217mm	75 Micron Polyester	10	STAMT48217Y75	Miscellaneous

## XI Archival Accessories

All the Secol accessories are acid-free. They are designed to provide professional protection and preservation of any paper and photographic archives and collections.

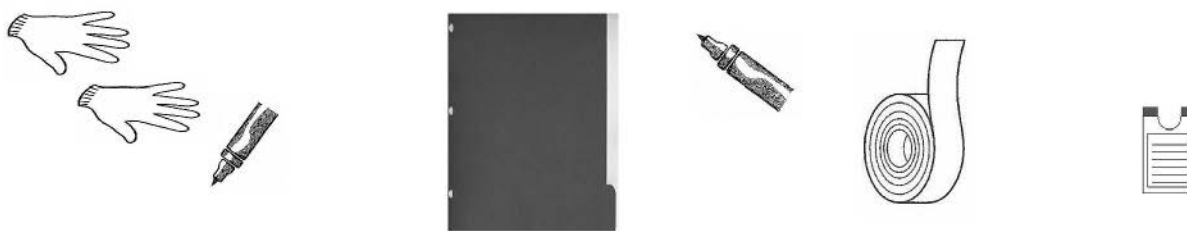

### 1 Interleaves and Board Tissue

The Standard Interleaves without Tabs are made of acid-free 160gsm Alpha cellulose paper, which is Ivory in colour with a slight calcium carbonate buffer. Interleaves With Tabs are also acid-free 1300 Micron 4-hole punched sheets. They are available in blue-grey or taupe boxboard. All Interleaves are available in any size as bespoke service so they can be use for a protective and visual barrier between pages and sections.

The Tissue 18 gsm is 100% cotton fibre board and calcium carbonate buffered. It is ideal for wrapping, interleaving and other archiving options.

NAME	DIMENSIONS	CATEGORY	PACK OF	REF. NO	SUITABLE FOR/APPLICATION
Interleaves A4 Without Tabs	320 x 260mm	160gsm Ivory Board	25	ASINLPWQ	Filing Pages/Separating, annotating, indexing
Interleaves A4 Without Tabs	320 x 260mm	160gsm Ivory Board	50	ASINLPW	Filing Pages/Separating, annotating, indexing
Interleaves A3 Without Tabs	440 x 340mm	160gsm Ivory Board	25	INLPWA3Q	Filing Pages/Separating, annotating, indexing
Interleaves A3 Without Tabs	440 x 340mm	160gsm Ivory Board	50	INLPWA3	Filing Pages/Separating, annotating, indexing
Interleaves A4 With Tabs	320 x 280mm	1300Micron Blue-Grey Board	8	IPD8A4	Filing Pages/Separating, annotating, indexing
Interleaves A4 With Tabs	320 x 280mm	1300Micron Taupe Board	8	IPD8A4T	Filing Pages/Separating, annotating, indexing
Board Tissue	500 x 750mm	18 gsm Cream Board	500	AFT500750G18	Wrapping, interleaving
Board Tissue	750 x 1000mm	18 gsm Cream Board	500	AFT7501000G18	Wrapping, interleaving

### 2 Labels, Index Cards and Marker Pens

Self Adhesive Labels are designed to complement our storage products. They provide a professional finish when printed with inkjet or laser printers from any standard software. The paper is very pale cream 100% Cotton Fibre, yet desktop printer friendly and the acrylic based resin adhesive is exceptionally stable.

Spine Label Holders supply a flexible indexing system. The pockets come complete with card index which can be updated whenever the file's content are changed.

Two Sided Printed Index Cards are available separately in Packs of 50. Index Cards 120 x 155mm perfectly fit CD & DVD Archival Pockets 127 x 172mm (Turn to page 14 or 33).

The instant dry, highly stable Marker Pens have a fine 4mm writing point. They are useful for all types of marking.

NAME	DIMENSIONS	PACK OF	REF. NO	SUITABLE FOR/APPLICATION
Ink Jet Labels	27 labels 63x32mm	100	AFL3263	Binders, boxes etc./Labelling, indexing
Ink Jet Labels	9 labels 63x96mm	100	AFL6396	Binders, boxes etc./Labelling, indexing
Spine Label Holder	43 x 89mm	25	SLH4389F5	Binders, boxes etc./Indexing
Double Sided Printed Index Cards	146 x 100mm	50	ICD01	2 CD & 2 Index Pockets Pages/Indexing
Tamper Evident Security. Additional Labels	13 x 15mm	100	LB13M51	Slide Security Pockets/Prevention of unauthorized use
Black Marker Pen	0.4mm tip	1	MPBL1	Polyester, board etc./Marking
Green Marker Pen	0.4mm tip	1	MPGR1	Polyester, board etc./Marking
Red Marker Pen	0.4mm tip	1	MPRE1	Polyester, board etc./Marking

### 3 Polyester Rolls

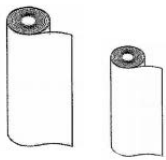

Standard Polyester Rolls, available in 610mm and 1000mm widths are useful for producing individual enclosures in conjunction with Double Sided Tape 9 (see page 39). Secol Polyester Rolls in 75 Micron are also available in various formats as Bespoke Service.

*For a Request Form Turn to page 47.*

NAME	DIMENSIONS	CATEGORY	PACK OF	REF. NO	APPLICATION
Standard Polyester Roll	610mm x 25m	Polyester 75 Micron	1	PR610M25Y75	Individual enclosures
Standard Polyester Roll	610mm x 50m	Polyester 75 Micron	1	PR610M50Y75	Individual enclosures
Standard Polyester Roll	1000mm x 25m	Polyester 75 Micron	1	PR1000M25Y75	Individual enclosures
Standard Polyester Roll	1000mm x 50m	Polyester 75 Micron	1	PR1000M50Y75	Individual enclosures

### 4 Handling Accessories



The high quality, soft, lint free cotton Gloves are designed for handling valuable materials and preventing skin oils from contaminating them. Corner Protectors are manufactured in high strength material to protect plain pictured canvas, frames, books and other delicate items. They are available in any sizes as bespoke service.

*For a Request Form Turn to page 47.*

NAME	DIMENSIONS	CATEGORY	PACK OF	REF. NO	APPLICATION
Archive Gloves	Large	White Cotton	5	GLV5L	Handling valuable materials & preventing them from contamination
Archive Gloves	Medium	White Cotton	5	GLV5M	Handling valuable materials & preventing them from contamination
Corner Protectors	105 x 155 x 50mm	Blue-Grey Board	4	CP10515550/4	Corner protection of frames, canvas, books etc.
Corner Protectors	105 x 155 x 50mm	Blue-Grey Board	20	CP10515550/20	Corner protection of frames, canvas, books etc.
Corner Protectors	205 x 295 x 30mm	Blue-Grey Board	4	CP20529530/4	Corner protection of frames, canvas, books etc.
Corner Protectors	205 x 295 x 30mm	Blue-Grey Board	20	CP20529530/20	Corner protection of frames, canvas, books etc.

### 5 Conservation Pack

#### FHKIT Family History Starter Kit

The Secol Conservation "Sampler" Pack is an introductory pack of "A-S" System of Binders & Pages and associated products to assist in establish a new archive.

#### It contains

- 1 x GBA4 Box Binder,
- 10 x AS200P1SE 1 pocket pages,
- 10 x AS201P2SE 2 pocket pages,
- 10 x AS202P4SE 4 Pocket pages,
- 10 x A4 Acid Free Mount Inserts
- 1 Pair Cotton Archive Gloves,
- 1 Pack V-Mount Mounting strips,
- 1 Pack Stamtec Display Mounts,
- 1 "Beginners Guide"

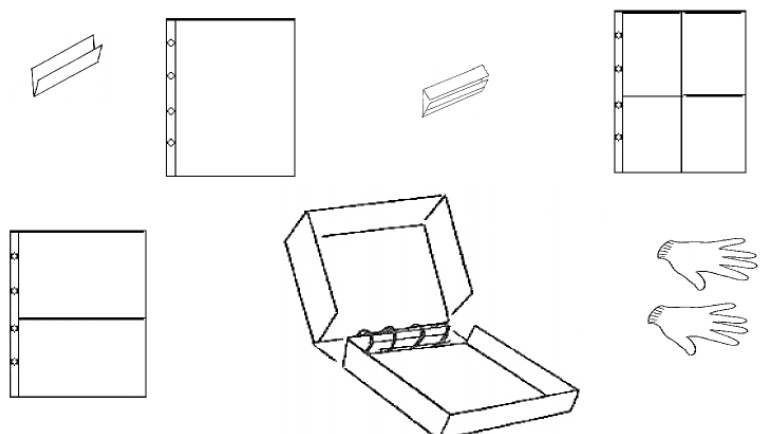

## XII Bespoke Service

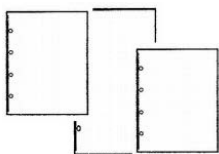

Secol are the pioneers and originators of the archival use of polyester film and have over 55 years experience in the manufacture

of archival storage in standard and Bespoke Formats. Please feel free to contact us for bespoke quotation.

*For a Request Form Turn to page 47.*

### BESPOKE PAGES AND INTERLEAVES

The Standard A-S Vertical Pages are also available as Three, Eight, Twenty-Four Pockets or other multi divisions to suit various requires as bespoke service. The Panoramic, Certificate Interleaves, Security Style Pages A2, A3 and A4 Formats in Packs of 10 are available as Bespoke Service.

NAME	DIMENSIONS	CATEGORY	PACK OF	REF. NO
B. S. Security Style Pages	220x305mm/A4	75 Micron Polyester	10	BSP1A4SC4Y75LSX
B. S. Security Style Pages	320x430mm/A3	75 Micron Polyester	10	BSP1A3SC4Y75LSX
B. S. Security Style Pages	440x600mm/A2	75 Micron Polyester	10	BSP1A2SC4Y75LSX
B.S. Panoramic Interleaves Without Tabs	1200 x 310mm	160gsm Ivory Board	10	BSINSPAN
B.S. Certificate Interleaves without Tabs	400 x 260mm	160gsm Ivory Board	10	BSINSCER
B.S. Outsize Interleaves without Tabs	Bespoke	160gsm Ivory Board	10	BSINLPW
B.S. Interleaves With Tabs	440 x 340mm	1300 Micron Taupe Board	10	BSIPD8A3T
B.S. Interleaves With Tabs	440 x 340mm	1300 Micron Blue-Grey Board	10	BSIPD8A3

### BESPOKE POCKETS, COVERS AND SLEEVES

Polyester Pockets, Covers and Sleeves are available in a wide range of formats (turn to page 13) but if the size you require is not listed, please feel free to contact us for a bespoke quotation. Simply let us know dimensions and quantity.

NAME	CATEGORY	FORMAT	REF. NO	APPLICATION
B.S. Archival Pockets	80 Micron	Other Sizes	BSHCP	Bespoke Requirements
B.S. Standard Pockets	50 Micron	Other Sizes	BSP1Y50	Bespoke Requirements
B.S. Standard Pockets	75 Micron	Other Sizes	BSP1Y75	Bespoke Requirements
B.S. Standard Pockets	100 Micron	Other Sizes	BSP1Y100	Bespoke Requirements
B.S. Standard Covers	50 Micron	Other Sizes	BSCY50	Bespoke Requirements
B.S. Standard Covers	75 Micron	Other Sizes	BSCY75	Bespoke Requirements
B.S. Standard Covers	100 Micron	Other Sizes	BSCY100	Bespoke Requirements
B.S. Standard Sleeves	50 Micron	Other Sizes	BSSY50	Bespoke Requirements
B.S. Standard Sleeves	75 Micron	Other Sizes	BSSY75	Bespoke Requirements
B.S. Standard Sleeves	100 Micron	Other Sizes	BSSY100	Bespoke Requirements
B.S. Postcard Sleeves	36 Micron	Other Sizes	BSSLP	Bespoke Requirements
B.S. Transleeves® Pack of 50	50 Micron	any	BSSLT	Bespoke Requirements
B.S. Colourview® Sleeves Packs of 50	50 Micron	any	BSSLC	Bespoke Requirements

NAME	FORMAT	PACK OF	REF. NO
B.S. Transleeve Divided Sheets	295x241mm/310x190mm/382x165mm	50	BSDSMT
B.S. Colourview® Divided Sheets	295x241mm/310x190mm/382x165mm	50	BSDSMT
B.S. Tamper Evident Security Labels	13x15	500	BSLB13M51H

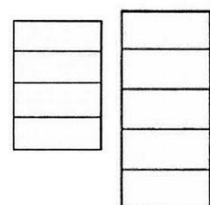

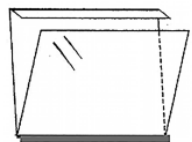

## BESPOKE FOLDERS & TRANTEC®

NAME	CATEGORY	FORMAT	PACK OF	REF. NO
B. S. Standard Folders	50 Micron	Other Sizes	Bespoke	BSF50
B. S. Standard Folders	75 Micron	Other Sizes	Bespoke	BSF75
B. S. Standard Folders	100 Micron	Other Sizes	Bespoke	BSF7100
B. S. Trantec® Sleeves	50 Micron	Other Sizes	Bespoke	BSTTY50T

## BESPOKE POLYESTER ROLLS

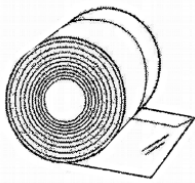

NAME	CATEGORY	FORMAT	PACK OF	REF. NO
B.S. Transleeve® Roll	50 Micron	Other Sizes	1	BSRSMT
B.S. Colourview® Sleeve Roll	50 Micron	Other Sizes	1	BSRSMC
B.S. Trantec® Sleeve Roll	50 Micron	Other Sizes	1	BSCFMT
B.S. V Mount Welded Roll	75 Micron	Other Sizes	1	BSAMTSTVY75
B. S. Polyester Roll	75 Micron	Other Sizes	1	BSPRY75
B. S. Polyester Roll for Industrial Purposes	Various Sizes		1	BSPRYI

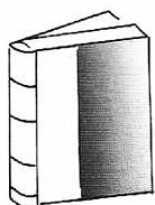

## BESPOKE BINDERS, BOXES AND OTHER ARCHIVAL PRODUCTS

NAME	FORMAT	COLOUR	PACK OF	REF. NO
B.S. Boxboard Binder	Other Sizes	Blue-Grey	1	BSGB
B.S. Boxboard Binder	Other Sizes	Taupe	1	BSGBT
B.S. Slipcase for Binder	A3	Maroon	1	BSA3SC
B.S. Collection Binder	A3	Green Buckram	1	BSCCA3B
B. S. Archival Box 1100 Micron	Various Sizes	Blue-Grey	1	BSB01BG11
B. S. Archival Box 1100 Micron	Various Sizes	Taupe	1	BSB01TG11
B. S. Archival Box 1300 Micron	Other Sizes	Blue-Grey	1	BSB01BG13
B. S. Archival Box 1300 Micron	Other Sizes	Taupe	1	BSB01TG13
B.S. Box & Lid	Various Sizes	Blue-Grey	1	BSB05BG13
B.S. Box & Lid	Various Sizes	Taupe	1	BSB05TG13
B.S. Box & Vizi Lid	Various Sizes	Blue-Grey	1	BSBV5BG13
B.S. Box & Vizi Lid	Various Sizes	Taupe	1	BSBV5TG13
B. S. Mounted Slide Box	Various Sizes	Blue-Grey	1	BSMSBBG
B. S. Mounted Slide Box	Various Sizes	Taupe	1	BSMSBT
B.S. Multi Drawer Box	Various Sizes	Blue-Grey	1	BSMDB
B.S. Multi Drawer Box	Various Sizes	Taupe	1	BSMDBT
B.S. Compartment Tray Box	Various Sizes	Blue-Grey	1	BSCTB
B.S. Compartment Tray Box	Various Sizes	Taupe	1	BSCTBT
B.S. Tube Box	Various Sizes	Blue-Grey	1	BSTUBE
B.S. Tube Box	Various Sizes	Taupe	1	BSTUBET
B. S. Archival Boarder Mounts	Various Sizes	Black	10	BSABM
B.S Board Folders 290gsm,	Other Sizes	Blue-Grey	10	BSSTO
B.S 4 Flap Folders	90x120mm 100x130mm 122x165mm 130x180mm 167x218mm	-	50	BS4FFL



## XIII Glossary of Terms

- 1. Binder Style Page**  
A polyester enclosure with holes, welded on three sides and open on one, separate binding and punched edge, access to storage material from top;
- 2. Cover**  
A polyester enclosure with no holes, welded on two adjacent sides
- 3. Folder**  
A polyester enclosure with no holes, welded on 1 long side and open on the other three
- 4. Hanging Style Page**  
A polyester enclosure with holes, welded on three sides and open on one, separate binding and punched edge, access to storage material from a binding edge
- 5. Page**  
A polyester enclosure welded on three sides and open on one; with holes
- 6. Pocket**  
A polyester enclosure with no holes, welded on three sides and open on one short side
- 7. Polyester**  
A condensation polymer formed by the reaction of a dicarboxylic acid with a diol followed by the elimination of H<sub>2</sub>O (or methanol).
- 8. Security Style Page**  
A polyester enclosure with holes, welded on three sides and open on one, access to storage material from punched edge
- 9. Sleeve**  
A polyester enclosure with no holes, welded on two parallel sides.
- 10. Trantec**  
A polyester enclosure with no holes, welded on 1 long side with a neat "captive flap" over the opposing edge

## XIV Polyester Properties and Archive Storage Guidelines

### POLYESTER PROPERTIES

1. Optical Transmission in the visible region of window glass.
2. Refractive Index 1.64 to 4.67
3. Melting Point 250 - 265 centigrade
4. Water vapour permeability, slight, 0.7g/m<sup>2</sup> 24 hrs/mm at 37.9 centigrade and 90% rh
5. Tensile Tear Strength (23 mu) 2800 kg/cm<sup>2</sup> at 25 centigrade (Higher than any other plastic film)
6. Propagated Tear Strength (23mu) 7.36N/mm
7. Initial Tear Strength (23mu) 250N/mm (Very much higher than PVC or Cellulose Acetate)
8. Folding Strength (23mu) 14,000 measured by M.I.T. at 1kg loading at 25 centigrade
9. Fungus Resistance, inert
10. Flammability, slow to self-extinguishing

### ARCHIVE STORAGE GUIDELINES

1. The Temperature ideally between 10 and 15 Centigrade. High temperatures can cause brittleness and mould growth, whilst temperatures too low can bring the risk of condensation, as can continual fluctuations in temperature.
2. The Relative Humidity (RH) should stay between 30 and 50% and wide fluctuations have the same dangers as temperature changes. High humidity is also associated with the problem of Glazing or Ferrotyping on photographic emulsions.
3. Avoid prolonged Exposure to both direct sunlight and standard fluorescent light which contain harmful UV Rays which cause yellowing of paper, fading of inks and rapid deterioration.
4. Original photographic prints are best stored in acid-free boxes and copies used for display where possible

## XV Request Form

PLEASE FILL IN THE FORM BELOW

(or complete online at [www.secol.co.uk](http://www.secol.co.uk)), describing your requirement in as much detail as possible.

All your details are stored securely and will never be released to third parties.

Send your completed form to:

Secol Ltd, Howlett Way, Thetford,  
Norfolk IP24 1HZ UK.

Fax: 01842 762 159 Email: [sales@secol.co.uk](mailto:sales@secol.co.uk)

We will contact you to discuss your requirements.

### SECOL REQUEST FORM

First Name	<input type="text"/>	Surname	<input type="text"/>
Company	<input type="text"/>	Position	<input type="text"/>
Address	<input type="text"/>		
City	<input type="text"/>	Postcode	<input type="text"/>
County	<input type="text"/>	Country	<input type="text"/>

#### ITEM FOR REQUEST (Please tick)

- |   |  |   |
|---|--|---|
| <input type="checkbox"/> Filing Page (with holes) | <input type="checkbox"/> Plan Chest                        | <input type="checkbox"/> Portfolios                       |
| <input type="checkbox"/> Folders (welded 1 side)  | <input type="checkbox"/> Pockets (welded 3 sides)          | <input type="checkbox"/> Covers (welded 2 adjacent sides) |
| <input type="checkbox"/> Transleeve® Rolls        | <input type="checkbox"/> Sleeves (welded 2 opposite sides) | <input type="checkbox"/> Polyester Rolls Trantec® Rolls   |
| <input type="checkbox"/> V Mount Welded Rolls     | <input type="checkbox"/> Colourview® Rolls                 | <input type="checkbox"/> Mounting Inserts                 |
| <input type="checkbox"/> Boarder Mounts           | <input type="checkbox"/> Interleaves                       | <input type="checkbox"/> Boxes                            |
| <input type="checkbox"/> Binders                  | <input type="checkbox"/> Board Folders                     | <input type="checkbox"/> Accessories                      |

Other - please provide details

Width (open)	<input type="text"/> In mm	<input type="text"/> In cm	<input type="text"/> In inches
Length (open)	<input type="text"/> In mm	<input type="text"/> In cm	<input type="text"/> In inches
Thickness (if known)	<input type="text"/> In micron	<input type="text"/> In mm	<input type="text"/> In gsm

Colour  Quantity

Other details

# Secol

## GIVING THE PAST A FUTURE

Secol was established in London in 1958 by Bertram Edward Charles Green and the company name arose from his deep vision and desire to enable people to see colours of precious archival collections and memorabilia.

After The Second World War, most of the Museums and Archives were looking for a better solution for preservation of their vulnerable materials. Consequently, Polyester film became a perfect medium for protecting, storing and presenting materials, whilst allowing their true colours to be seen.

The Company was relocated to Thetford in Norfolk in the 60's where it remains today, in a custom built factory. In 1992 Secol Limited, was awarded the Royal Warrant, for the supply of Archival and Photographic Storage Products to Her Majesty Queen Elizabeth II.

Many have tried to emulate its success but Secol Limited is still the unbeaten market leader. To keep meeting today's requirements, the company has recently undertaken significant capital investment in new machinery, allowing the range of products to be increased.

Now, Secol supplies archival products to the some of the world's foremost galleries, museums and photographic libraries, as well as to a wide range of private collectors and history enthusiasts.

We are proud of our loyal and well trained workforce and this cannot be overvalued in the current uncertain times.

All these factors play a key role in Secol maintaining its mission to treasure the past in the best possible way and to save it for future generations.

Secol Ltd  
Howlett Way  
Thetford  
Norfolk  
IP24 1HZ  
UK  
Tel: 01842 752 341  
Email: [sales@secol.co.uk](mailto:sales@secol.co.uk)  
Website: [www.secol.co.uk](http://www.secol.co.uk)